

***RXTE* Observations of GRS 1758–258: Long-Term Variability of a Black Hole**

Bachelorarbeit

vorgelegt von
Maria Obst

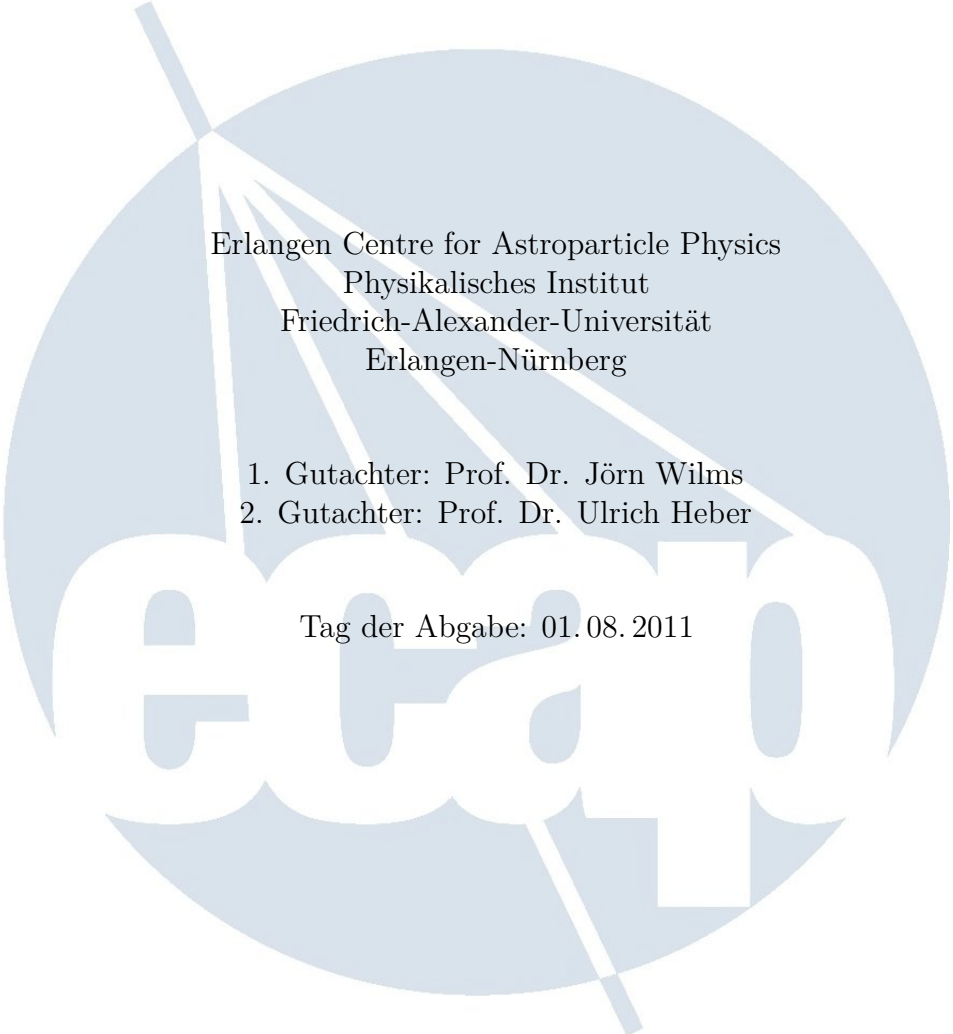

Erlangen Centre for Astroparticle Physics
Physikalisches Institut
Friedrich-Alexander-Universität
Erlangen-Nürnberg

1. Gutachter: Prof. Dr. Jörn Wilms
2. Gutachter: Prof. Dr. Ulrich Heber

Tag der Abgabe: 01.08.2011

Contents

1. Source and Satellite	6
1.1. End stages of stellar evolution	6
1.2. Black holes	7
1.2.1. Active Galactic Nuclei	7
1.2.2. (Micro-) Quasars	8
1.3. Instrumentation	9
2. <i>RXTE</i> Monitoring	12
2.1. GRS 1758–258- A Black Hole Candidate	12
2.2. Data Reduction	13
2.3. Background Modeling	14
2.4. Data Analysis	16
3. Disk-Jet-Coupling	19
3.1. X-ray states of Black Hole Binaries	19
3.2. Hardness-Intensity Diagrams	20
3.3. The “own way” of GRS 1758–258	21
4. Conclusions and Outlook	23
A. Appendix	24

GRS 1758–258 is the least studied of the only three persistent black hole binaries in our Galaxy. It is also one of only two known black hole candidates, including all black hole transients, which shows a decrease of its 3–10 keV flux when entering the thermally dominated soft state, rather than an increase.

RXTE PCA observations of GRS 1758–258 spanned a time of about eleven years from 1996 to 2007. The spectral evolution of GRS 1758–258 in this time is presented here. During the monitoring, seven dim soft states are detected. In addition, *INTEGRAL* monitoring observations of the source are considered. The long-term behavior of GRS 1758–258 is compared to that of the bright persistent black hole X-ray binary Cyg X-1. The observed state transitions are discussed in the light of physical scenarios for black hole transitions.

Parts of this work have been presented at the 8th *INTEGRAL*/BART Workshop, April 26-29, 2011, in Karlovy Vary, Czech Republic as well as “The X-ray Universe 2011” Symposium, June 27-30, 2011. Proceedings for the Karlovy Vary workshop are submitted and will be published in the refereed journal “Acta Polytechnica”.

“Begin at the beginning”, the King said gravely, “and go on till you come to the end: then stop.”

(Lewis Carroll, “Alice in Wonderland”)

1. Source and Satellite

The first chapter of this thesis gives a short summary of the final stages of stellar evolution, talks about Galactic black holes in comparison to black holes in the centers of active galactic nuclei, and introduces the Unified Model for active galactic nuclei as well as its equivalent for a certain kind of Galactic black holes, so-called microquasars. Unless noted differently, all information given in this chapter can be found in basic literature, e.g., “An Introduction to Modern Astronomy” by Carroll & Ostlie (1996) or “Fundamental Astronomy” by Karttunen et al. (2007). For more information on active galactic nuclei and the Unified Model see, e.g., “An Introduction to Active Galactic Nuclei” by Peterson (1997). The contents of this chapter are also covered by the astronomy lectures given at the University of Erlangen-Nuremberg. Finally, also the instrumentation is described that was used to obtain the data that were analyzed. For more detailed information on the detection of particles and radiation in general, see, e.g., “Particle Detectors” by Grupen & Shwartz (2008).

1.1. End stages of stellar evolution

We know for quite a while now that most stars in our Galaxy do not stand alone like our Sun, but are bound in systems of two or even more. If one companion in such a system reaches the final stage of stellar evolution, several scenarios are possible:

White dwarf. If the star has a low mass, it will form a white dwarf. The other companion of the system remains on the main sequence. It is possible that the main sequence companion loses mass to the compact object. This mass transfer can happen either via Roche lobe overflow or via wind accretion. Material forms an accretion disk around the compact object, loses kinetic energy e.g. due to friction, thus spirals inward and finally is accreted onto the compact object.

Neutron star. Stars of higher masses undergo a supernova explosion. The remaining core forms either a neutron star, for masses greater than the *Chandrasekhar limit* (Chandrasekhar, 1931) at $\sim 1.4 M_{\odot}$, or a black hole. In case of a neutron star with a strong magnetic field, the accretion disk only reaches inward down to a minimal radius called “Alfvén radius”. This is the radius where the magnetic stress dominates the accretion flow. From here, the charged particles follow the magnetic field lines and, due to Lorentz force, spiral towards the magnetic poles of the neutron star. Close to the neutron star surface, this accretion flow is concentrated to high densities due to the stronger magnetic field. Hot spots form where the particles hit the neutron star surface. Via Compton scattering high energy photons are emitted. If the rotation axis of the neutron star is tilted with respect to the magnetic field axis, the radiation cone moves like a lighthouse beam. Observed from the Earth regular pulses can be seen, telling us the rotation period of the neutron star. Such an object is then called an X-ray pulsar.

Black hole. If the mass of the remaining core exceeds the *Oppenheimer-Volkoff limit* (Oppenheimer & Volkoff, 1939) of $\sim 3 M_{\odot}$, the resulting density would become greater than what is

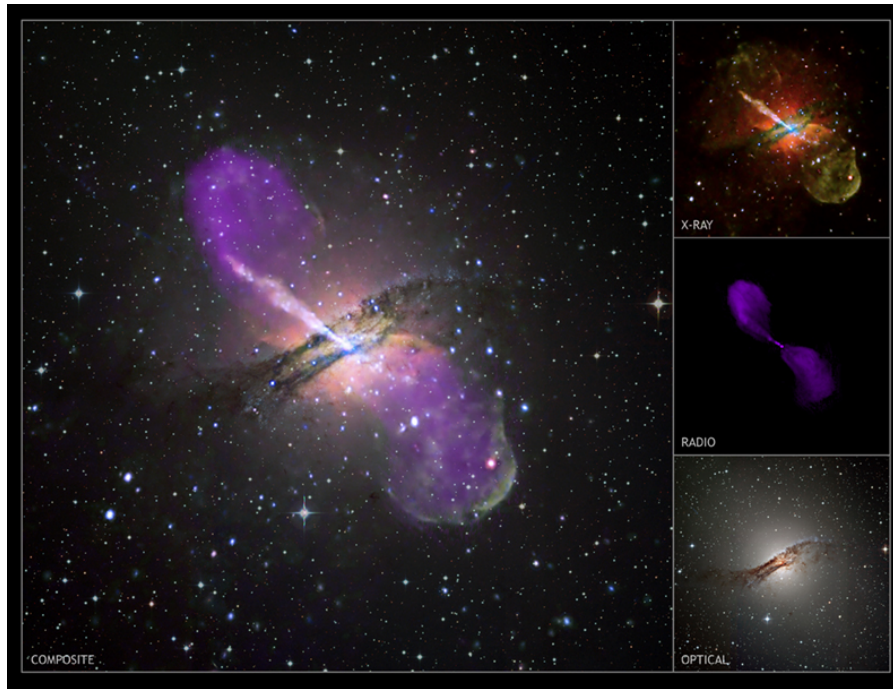

Figure 1.1.: *Multiwavelength composition of Centaurus A, a radio loud AGN. Jets can be seen mainly in the radio and, from the central regions, also in the X-rays, while in the optical a band of dust hides the inner part of the galaxy.* <http://chandra.harvard.edu/photo/2008>

supported by degeneracy, the enormous gravitational forces dominate by far, the gravitational collapse continues and a black hole is formed, a singularity in time and space surrounded by an event horizon. In the simplest case, this is the *Schwarzschild radius* (Schwarzschild, 1916), the radius where the escape velocity starts to exceed the speed of light:

$$R_s = \frac{2GM}{c^2} \quad (1.1)$$

where R_s is the Schwarzschild radius, G is the Gravitational constant, M is the black hole mass and c is the vacuum speed of light.

Due to relativity, observers cannot see anything that happens behind the event horizon. Once behind it, neither matter nor light can escape gravitational attraction of the black hole. But, however difficult the mathematics are to describe the singularity, according to the “No Hair Theorem”, such a black hole is physically fully described by its mass, angular momentum, and electromagnetic charge (Carter, 1971).

1.2. Black holes

Different kinds of black holes range from stellar mass black holes, that originate in a supernova explosion and are found in binary systems, up to primordial supermassive black holes as active galactic nuclei (AGN). Since none of them can be observed directly, astronomers gather information by looking at the radiation of accreted matter, or, in some cases, the relativistic outflows of the black hole, i.e., its jets.

1.2.1. Active Galactic Nuclei

The most prominent examples for black holes are probably radio-loud AGN. What in the optical is so bright that one can only observe a point on the sky (“quasi-stellar objects”, or “quasars”,

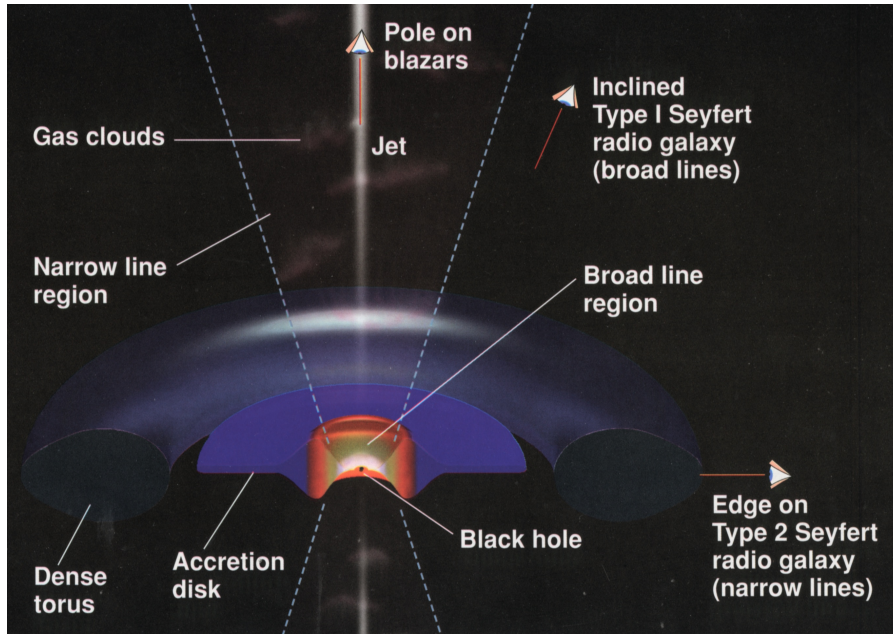

Figure 1.2.: Schematic drawing of the unified model for active galactic nuclei; <http://crab0.astr.nthu.edu.tw/~hchang/ga2>

see also section 1.2.2, with luminosities of $\sim 10^{13} L_{\odot}$ in the optical (Peterson, 1997)), shows also a bright X-ray bright core region, jets and extensive radio lobes. Such objects allow for detailed studies of the relativistic effects that are present in the vicinity of black holes. From apparent superluminal motion of jet components (first discovered by Cohen et al. (1971); Whitney et al. (1971)) to relativistic beaming of radiation there are many interesting effects to analyze.

However, not all AGN have jets. As the radio photons are emitted mainly in the jet, those with jets are called radio-loud AGN, those without jets radio-quiet AGN, mostly Seyfert galaxies. Although their optical luminosities are about a factor of 100 dimmer than the radio-loud AGN, they are still very bright sources. Sometimes the observer looks directly into one of the jets. In this case the object is called a *blazar*.

The *Unified Model* (Urry & Padovani, 1995, and references therein) tries to describe all the different phenomenologies that are observed at once. The general idea is shown in Fig. 1.2. The black hole in the center of the AGN is surrounded by an accretion disk and a dense torus of dust. Broad emission lines originate in the regions close to the core. For edge-on observers, these lines are hidden by the dusty torus. Above the galactic plane, clouds of gas emit both allowed and, due to the extremely low densities, forbidden narrow lines.

1.2.2. (Micro-) Quasars

The most luminous AGN are also called quasars, quasi-stellar objects. They vary on very long timescales. The smallest time scale typical for such objects is the period of the lowest possible orbit, i.e. at the Schwarzschild radius. Taking Kepler's third law,

$$\frac{P^2}{a^3} = \frac{4\pi^2}{GM} \quad (1.2)$$

with the period P and the semimajor axis a , one gets for an orbit at the Schwarzschild radius

$$P = \frac{\sqrt{32}\pi GM}{c^3} \sim 8.8 \times 10^{-5} \text{ s} \frac{M}{M_{\odot}} \sim 8800 \text{ s} \frac{M}{10^8 M_{\odot}} \quad (1.3)$$

Thus, the period and also the variability of a black hole scales linearly with its mass and less massive black holes vary on shorter timescales.

Hence, also more impatient observers are provided for: There are stellar mass black holes in binary systems that show a very similar behavior as AGN. They have accretion disks and jets and are strongly variable. Because of the characteristics they have in common with quasars, they are called microquasars.

In most cases, microquasars are transient sources, i.e., showing irregular outbursts, probably due to disk instabilities (Remillard & McClintock, 2006). During their quiescent states, they are invisible in the X-rays. Most of all ~ 20 known galactic black holes fall in this category. GRS 1758–258 on the other hand is one of only three known persistent black hole binaries. Most of the time it is in the hard state, i.e., its $\nu f\nu$ spectrum is relatively flat. Still it sometimes displays a behavior typical for transient sources: Once in a while, it fades into a dim, decay-like soft state in which the spectrum becomes steeper. For more information on the properties of the hard and soft states of black hole binaries, see Chap. 3. The track of GRS 1758–258 in the hardness-intensity diagram (HID, see also Chap. 3) shows a clear hysteresis, i.e. a region in luminosity in which both hard and soft states can occur.

1.3. Instrumentation

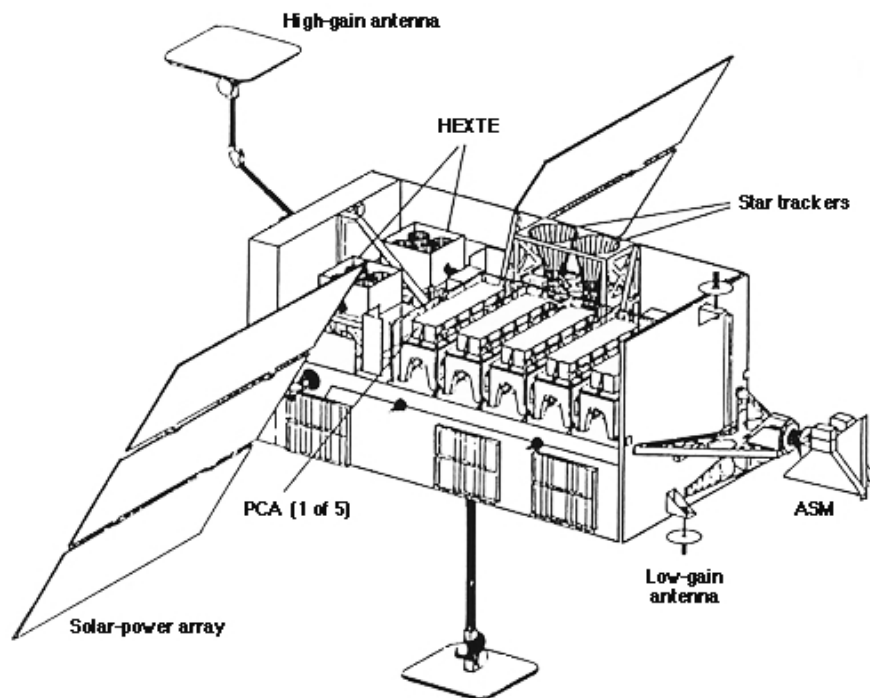

Figure 1.3.: Schematic drawing of RXTE <http://mamacass.ucsd.edu/hexite/>

The data of GRS 1758–258 used in this work are taken by the *RXTE* satellite, the **R**ossi **X**-ray **T**iming **E**xplorer¹. *RXTE* is a NASA mission and was launched in 1995 December into a circular, low-earth orbit at a height of 580 km with an orbital period of 90 minutes and an inclination of 23°. It transfers its data to the ground via the NASA TDRSS satellites. Being able to move with up to 6° per minute, *RXTE* is able to observe changing sources also on short notice. However, no pointings are possible within 30° from the sun.

¹Information found on <http://heasarc.gsfc.nasa.gov/docs/xte/XTE.html>

There are three instruments onboard *RXTE*, sensitive to a whole range of energies and meant for observing known sources, detecting and studying transients and periodic changes in the X-ray flux. A short overview is given here, for more detailed information see the respective instrumentation papers.

ASM. The **All Sky Monitor** (Levine et al., 1996), consisting of three wide angle cameras with proportional counters, has a total collecting area of 90 square centimeters. In the energy range of 2 – 10 keV the cameras, each having a field of view of $6 \times 90^\circ$, cover 80% of the sky in every orbital period. It monitors the sky for unusual behavior of sources. Data are processed already on board before being sent down to the ground. ASM lightcurves of many sources are available online ².

HEXTE. The **High Energy X-ray Timing Experiment** (Rothschild et al., 1998) consists of 2×4 phoswich scintillation detectors. Sensitive in the energy range of 15 – 250 keV, HEXTE is meant for gathering timing information of compact objects as well as for AGN. Originally, to be able to distinguish between source and background photons, each of the two arrays was “rocking” between the on-source and an off-source position and thus providing a sufficient background to be subtracted from the data later. However, due to mechanical problems, first HEXTE A was parked in its on-source position in 2006 October to avoid freezing at just some point and making the instrument unusable furtheron. From that time onwards, the HEXTE B detector was used to measure the background also for HEXTE A. Just a few years later, in 2009 December, the same problems occurred in the second array and since that, HEXTE B is parked to an off-source position to be able to provide the background information for HEXTE A³.

PCA. The data used in this work were taken by the **Proportional Counter Array** (Jahoda et al., 1996). PCA’s five proportional counters have a total collecting area of 6500 square centimeters. Working in the energy range of 2 – 60 keV with a medium energy resolution, its time resolution is one microsecond and its spatial resolution given by a collimator with 1° FWHM.

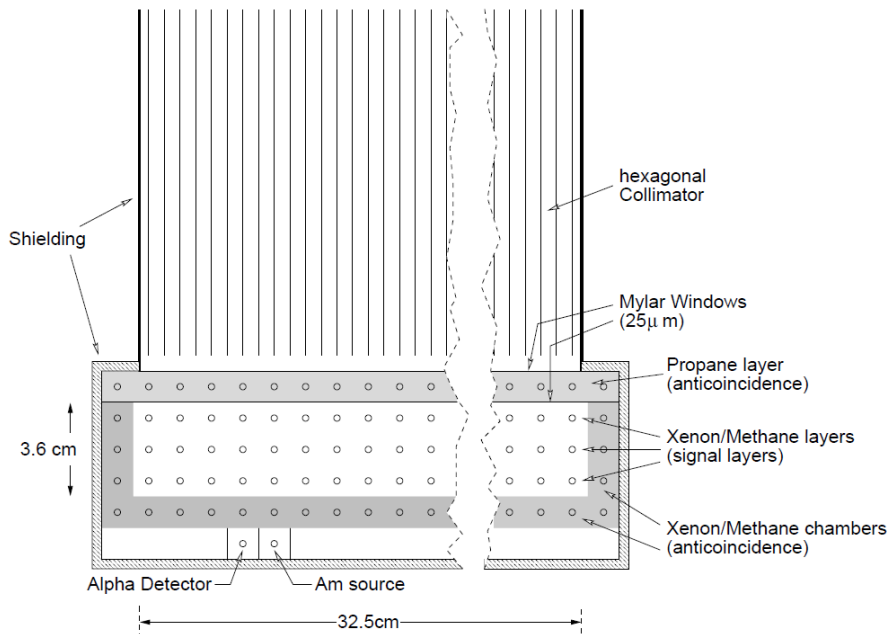

Figure 1.4.: Schematic drawing of *RXTE* PCA (Wilms, 1998, Dissertation)

The five identical **Proportional Counter Units** (PCUs) consist of the collimator, a propane layer for anticoincidence and the xenon/methane layers used for signal detection, also surrounded

²http://xte.mit.edu/ASM_lc.html

³<http://heasarc.gsfc.nasa.gov/docs/xte/whatsnew/big.html>

by anticoincidence chambers. These layers act as veto layers to exclude unwanted background photons from off-source directions. Below these layers, there is an alpha detector and an americium source for gain calibration.

As by now, *RXTE* is quite old (it surpassed its required lifetime of two years as well as the goal of five years by far - almost ten years now - as it is still in space and taking data), the PCA detector has some problems. Not only are there several different calibration epochs because the high voltage had to be changed. Also, to extend the PCU's lifetime, in average only two of them are turned on at a time. Although still performing quite well for its age, *RXTE* will be switched off at the end of 2012.

When the satellite passes through the South Atlantic Anomaly, an irregularity in the Earth's magnetic field, the particle background is very high and PCA is switched off completely. A review of the evolution of the SAA as seen by *RXTE* was done by Fürst et al. (2009).

After a mission time of five years, the first of the five PCUs (PCU 0) lost its propane layer. Another six years later, a micrometeorite broke the propane layer of PCU 1. Although the two PCUs are still working, they now have a different gain and higher background.

Because the monitoring time of GRS 1758–258 includes most if these minor and major accidents, only PCU 2 was used for the whole analysis.

You see but you do not observe... It is a capital mistake to theorize before one has data.

(Sir Arthur Conan Doyle, "Scandal in Bohemia")

2. The *RXTE* Monitoring Campaign of GRS 1758–258

In the second chapter of this work, there is a short introduction to the source that was observed and analyzed, the black hole candidate GRS 1758–258. The extraction of the monitoring campaign data is described as well. A less technical and more scientific part includes information about the modeling of the Galactic ridge X-ray emission that contributes to the background flux in the observations of GRS 1758–258. The chapter closes with the modeling of the monitoring campaign data and the results on the long-term spectral evolution of GRS 1758–258.

2.1. GRS 1758–258- A Black Hole Candidate

First discovered in 1990 by the *Granat* astrophysical observatory, an X-ray satellite, during observations of the Galactic center region, (Syunyaev et al., 1991; Mandrou, 1990), GRS 1758–258 has been observed many times in different energy ranges. Its spectral and temporal evolution are similar to its “big brother” Cyg X-1 (Main et al., 1999; Lin et al., 2000). However, unlike Cyg X-1, GRS 1758–258 is not a high mass X-ray binary (HMXB) but the optical companion in the system is probably an early A-type main sequence star, but with unusual colors (Muñoz-Arjonilla et al., 2010). However, this identification is still ambiguous (Smith, 2010) and, as unlikely as it may seem, Muñoz-Arjonilla et al. (2010) even cannot exclude an extra-galactic origin. As the radio observations of Rodriguez et al. (1992) showed a double-lobed radio counterpart, GRS 1758–258 is considered a microquasar.

Mass transfer in the system is probably driven by Roche lobe overflow, if the companion is indeed a low mass star. Timing analysis of the X-ray data (outside of the scope of this thesis) is expected to shed light on its nature. However, low mass X-ray binaries (LMXB) are usually transients. GRS 1758–258 on the other hand is one of only three known persistent black hole binaries. Most of the time it is in the hard state. Still it sometimes displays a behavior typical for transient sources when it occasionally fades into a dim, decay-like soft state. Its track in the hardness-intensity diagram (HID, see Chap. 3) shows a clear hysteresis, i.e. a region in luminosity in which both hard and soft states can occur.

The first monitoring of GRS 1758–258 was done by *Granat*/Sigma from 1990 to 1998. In these observations, GRS 1758–258 showed a very similar behaviour to the other bright black hole candidate in the Galactic center region, 1E 1740.7–2942 (Kuznetsov et al., 1999). In addition to the hard X-ray monitoring by *INTEGRAL* since 2003 (Pottschmidt et al., 2006, 2008), GRS 1758–258 was also monitored by *RXTE* in the soft X-rays from 1996 to 2007. First, the 1 – 1.5 ks pointed snapshots were taken monthly, weekly from 1997 to 2000 and twice a week from march 2001 to October 2007. Due to the pointing restrictions of *RXTE*, there is a gap in the data each year between November and January because GRS 1758–258 is located too close

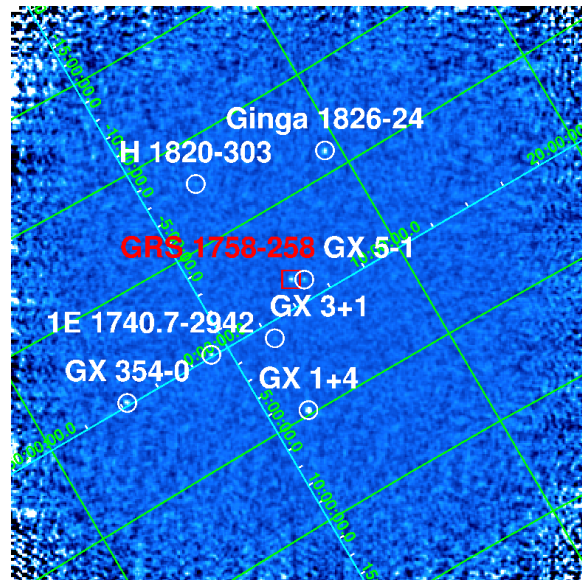

Figure 2.1.: *INTEGRAL-ISGRI count rate mosaic (Lohfink et al., 2011)*

to the sun. The monitoring of GRS 1758–258 was proposed by David Smith mainly to confine the system’s orbital period, to detect and study changes of state and analyse the anticorrelation between spectral hardness and flux.

However, pointings to GRS 1758–258 are not as easy as one might think in the first place. Figure 2.1 shows an *INTEGRAL-ISGRI* count rate mosaic image of the region around GRS 1758–258. It was obtained in the 20 – 40 keV band during the Galactic Center Region Key Programme observations in spring 2007. As one can clearly see, GRS 1758–258 is not only located close to the Galactic center in the Galactic plane, but there is also a very bright source, GX 5–1, less than one degree from the position of GRS 1758–258. As this source outshines GRS 1758–258 by far, the monitoring was realized by offset pointings. To avoid such contamination in the data, *RXTE* pointed to a position next to GRS 1758–258 so that GRS 1758–258 is in the field of view whereas GX 5–1 is not. This of course has to be taken into account during data extraction.

2.2. Data Reduction

The data, provided by HEASARC, the **H**igh **E**nergy **A**strophysics **S**cience **A**rchive **R**esearch **C**enter, were extracted using the software package HEASOFT. The steps of extraction can be looked up in the *RXTE* cook book¹, or, for the routines available at the Remeis observatory in Bamberg, on the websites of Jörn Wilms². The standard routine used produces a light curve of the source as well as of the background and five net light curves in different energy bands with a time resolution of 16 seconds and a spectrum containing 129 energy bins (channel 0–128) over the whole range of the PCA detectors, as well as background information for the spectrum and a response matrix file.

For the extraction, the following options were used:

- saa=15: Every day, about 6 consecutive orbits of *RXTE* involve a passage over the SAA. Even though the detectors are down during this passage, high energy particles end up in the detector and deposit their energy. The induced radioactivity needs about 30 minutes to decay before the background rate is again low enough. Thus, data taken in the first 15 minutes after such a passage are too contaminated. From about 15 minutes onward, the

¹http://heasarc.nasa.gov/docs/xte/recipes/cook_book.html

²<http://pulsar.sternwarte.uni-erlangen.de/wilms/research/analysis/rxte/standard.html>

background model is able to predict the remaining radioactivity and data can be used again.

- electron=0.5: The electron ratio, measured by a counter onboard *RXTE*, is a measure for the background particle flow. However, for soft sources, also soft X-ray photons can be part of the electron ratio. Therefore, the maximum value must not be too low. Here, data are used where the electron ratio is below 0.5.
- top: Only data from the top layer of the PCU are extracted.
- 2only: To avoid different normalizations in every spectrum due to the on- and off-times of different numbers of different PCUs with different sensibilities, just data from PCU 2 were used. PCU 2 so far is the best calibrated PCU and is on most of the times (Jahoda et al., 2006).
- offset: As the observations are offset pointings, the actual coordinates of the source have to be given. According to SIMBAD³, GRS 1758–258 is located at a right ascension of 270.3012° and a declination of –25.7433° in ICRS coordinates, epoch J2000.

2.3. Background Modeling

Once all spectra are extracted, one has to remember again the position of GRS 1758–258: it is a dim source close to the Galactic center, located in the Galactic plane. Thus, when *RXTE* is looking at the source, it not only receives source photons but also lots of background photons emitted in the Galactic ridge. To account for this background that cannot be subtracted as the instrumental background as it is a real signal, *RXTE* performed background observations of a total of 13 ks, located 1.5° offset from GRS 1758–258 in calibration epoch 4 (1999). Seven individual spectra were added. See Tab. A.1 for more details on the individual spectra. This summed spectrum contains only counts from the Galactic ridge emission. The position of such a background observation has to be chosen carefully. If it were located too close to the source, soft X-ray source photons would by mistake be interpreted as background photons and the spectrum of GRS 1758–258 itself would appear too hard.

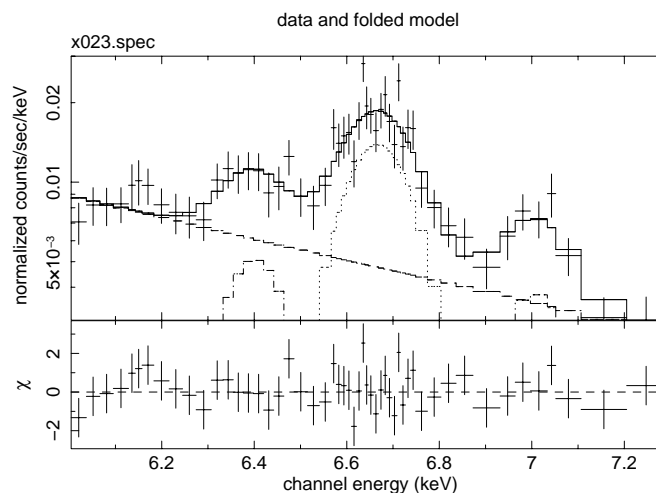

Figure 2.2.: *Iron K-emission line complex of the Galactic Ridge spectrum. *XIS0*, 2 and 3 (front-illuminated chips) are combined and the non-X-ray background is subtracted. Ebisawa et al. (2007), Fig. 2*

A continuum of two bremsstrahlung components fitted well to the data. In addition, iron K-emission lines had to be taken into account. According to a *Suzaku* observation taken in 2005,

³<http://simbad.u-strasbg.fr>

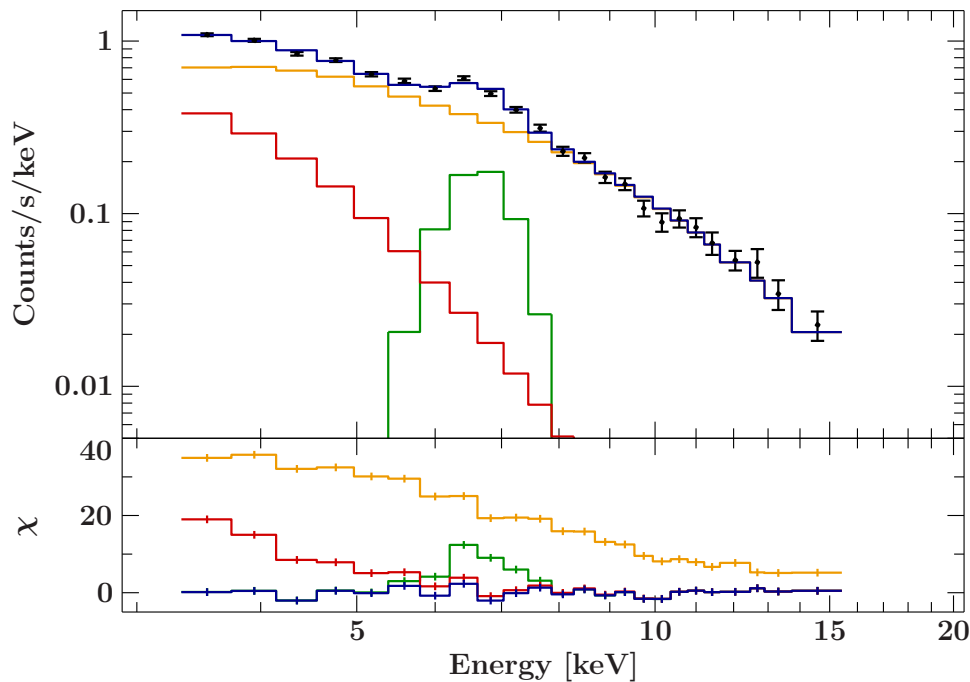

Figure 2.3.: Spectrum of the Galactic ridge emission. Two bremsstrahlung components (red (1) and orange (2)) and an iron line complex are fitted to the *RXTE* data. Residuals are highlighted the same, the fit excluding the respective model components.

the iron K-emission complex consists of three lines: low-ionized iron at 6.4 keV, helium-like iron at 6.67 keV, and hydrogen-like iron at 7.0 keV (Ebisawa et al., 2007). The equivalent widths of these lines scale as 85:458:129, respectively. The good resolution spectrum, taken with **X**-ray **I**maging **S**pectrometer (XIS) (Koyama et al., 2007) detectors onboard the *Suzaku* satellite, by Ebisawa et al. (2007) is shown in Fig. 2.2.

As the *RXTE* PCA detector is not able to resolve these lines, the energy values were taken according to Ebisawa et al. (Ebisawa et al., 2007) and the equivalent widths of the helium-like and hydrogen-like lines fixed to the width of the low-ionized iron line. Values for the complete model can be found in Table 2.1, a plot of the Galactic ridge X-ray emission and the model is shown in Fig. 2.3.

Table 2.1.: Background model parameters; values without errors were kept fixed during the fit

bremss(1).norm	0.011 ± 0.003	
bremss(1).kT	8_{-1}^{+3}	keV
bremss(2).norm	$0.05_{-0.01}^{+0.03}$	
bremss(2).kT	$1.2_{-0.1}^{+0.2}$	keV
egauss(1).area	$(2.6_{-0.4}^{+0.3}) \times 10^{-5}$	photons/s/cm ²
egauss(1).sigma	0.05	keV
egauss(1).center	6.4	keV
egauss(2).area	1.4×10^{-4}	photons/s/cm ²
egauss(2).sigma	0.05	keV
egauss(2).center	6.67	keV
egauss(3).area	4×10^{-5}	photons/s/cm ²
egauss(3).sigma	0.05	keV
egauss(3).center	7.0	keV

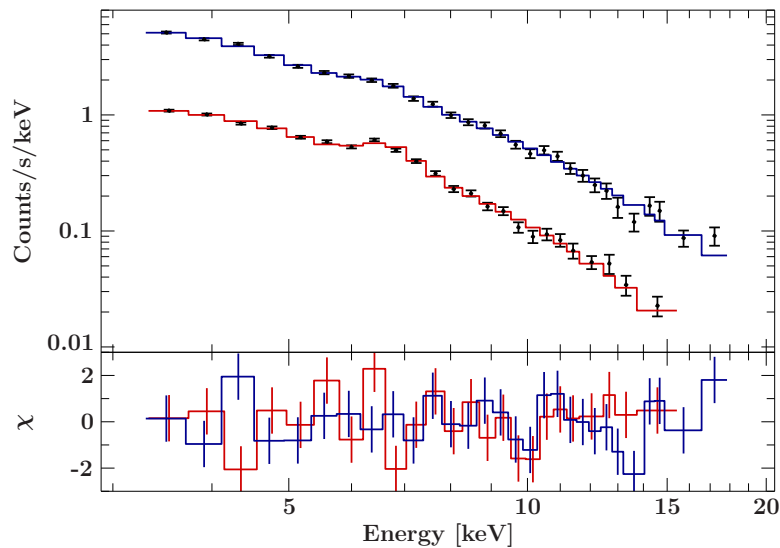

Figure 2.4.: *Spectrum of GRS 1758–258 obtained in April 2003 (blue), and spectrum of the Galactic ridge emission alone (red).*

The values of the best fit model for the Galactic ridge X-ray emission then were completely frozen and the whole background model was added as a constant to the model that describes the source emission itself. As one can see in Fig. 2.4, the part of the GRS 1758–258 spectra that is contributed by the Galactic ridge is not unimportant.

2.4. Data Analysis

Taking the Galactic ridge emission into account, the *RXTE*-PCA spectra were then modeled using an empirical model describes black hole spectra well. The continuum is described by an absorbed powerlaw, its photon index representing the hardness of each spectrum of the monitoring campaign. The source flux was calculated from the source model only, thus excluding

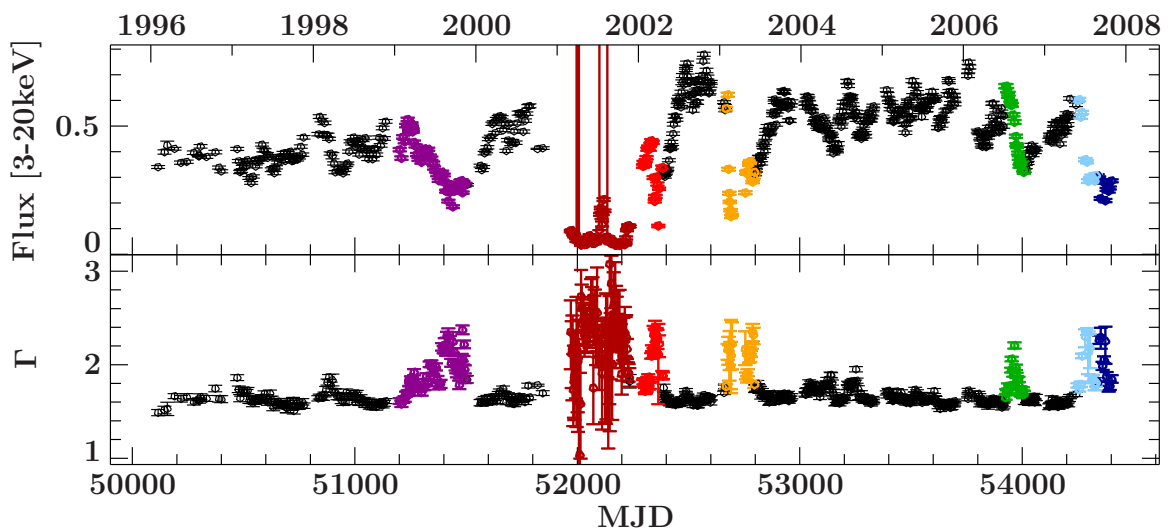

Figure 2.5.: *Top:* Flux in $\text{keV s}^{-1} \text{cm}^{-2}$ in the 3–20 keV band, fitted to the spectra taken by *RXTE*. *Bottom:* Photon index obtained from modeling. Soft states are highlighted for episodes reaching a photon index above 2.

the flux of the Galactic ridge emission. Comparing the evolution of the source flux to the evolution of the spectral hardness shows a very clear anti-correlation: The photon index varies between 1.5 and 3. Most of the time, GRS 1758–258 is in the hard state. However, seven dim soft states, during which the flux decreases and the spectrum softens, appear clearly in the data (Fig. 2.5). During the 2001 soft state (highlighted in dark red), the source almost turned off completely. This strong decline in flux makes GRS 1758–258 especially interesting as it is typical for transient, not for persistent sources (see also HID, Chap. 3 as well as Pottschmidt et al. (2006, 2008); Smith et al. (2001); Soria et al. (2011) for the state transitions).

Also the other spectral components show a variation over the eleven years of monitoring. The complete model consisted of the absorbed powerlaw continuum, a weak neutral iron $K\alpha$ line, and a blackbody disk where required (see Fig. 2.6 for an example fit).

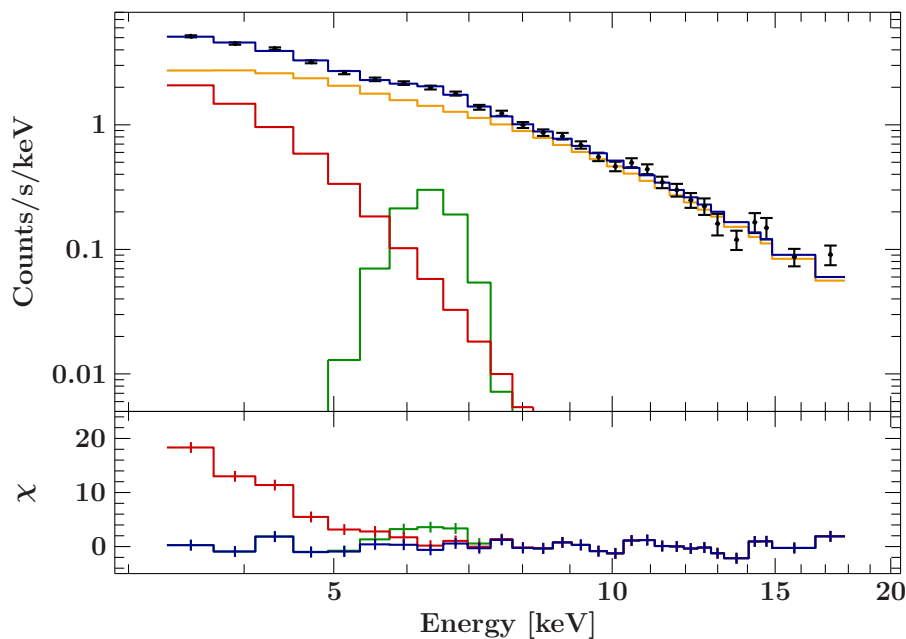

Figure 2.6.: Example spectrum taken by *RXTE* on April 8, 2009, containing the absorbed powerlaw component (orange), the disk (red) and the iron line (green). Residuals are color-coded the same, the fit excluding the components respectively.

The column density due to interstellar absorption in the direction of GRS 1758–258 is fixed at $N_{\text{H}} = 1.5 \times 10^{22} \text{ cm}^2$ according to earlier results (Pottschmidt et al., 2008). The width of the Iron line was fixed at 0.001 keV, well below the resolution of *RXTE* PCA, and only the equivalent width was free for fitting. The disk becomes visible only in the dim soft states, the low source flux increasing the error bars (see Fig. 2.7).

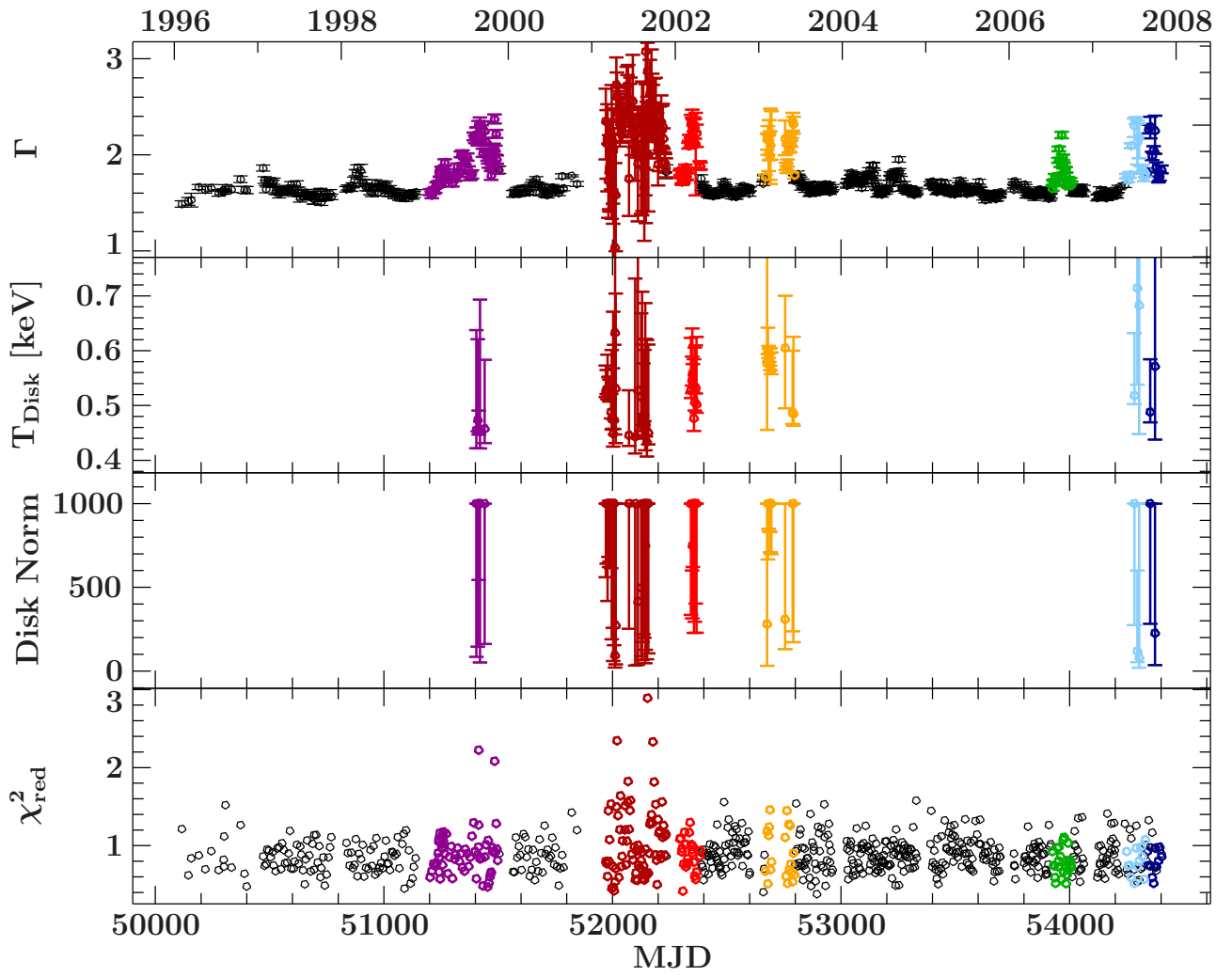

Figure 2.7.: Spectral parameters from RXTE monitoring observations of GRS 1758–258.

Everybody likes to go their own way - to chose their own time and manner of devotion.

(Jane Austen, "Mansfield Park")

3. Disk-Jet-Coupling in Black Hole Binaries

The third chapter of this work gives a short introduction to the different X-ray states of black hole binaries and their temporal evolution. The overall picture is given in the Unified Model for black hole X-ray binary jets that tries to describe the “q”-shaped track of such sources in the hardness-intensity diagram. This more general part of the chapter is structured following Remillard (2005) and Fender et al. (2004). Finally, the track of GRS 1758–258 in such a diagram is shown as well as a comparison to the “big brother” Cyg X-1.

3.1. X-ray states of Black Hole Binaries

Most spectra of black hole X-ray binaries can be described with two distinct components: a soft one, which usually is associated with thermal radiation of an accretion disk, and a harder one, whose origin is not yet understood. Two scenarios are under discussion: a Comptonizing corona or synchrotron and synchrotron self Compton emission induced by a jet. However, from fitting to data, one cannot distinguish between them. Both models describe the data equally well (Nowak et al., 2010).

But not only individual spectra can be modeled with these two components. Even during the whole spectral evolution of a source they can be retained. The temporal evolution of the two components can be summarized in three different X-ray states that can occur in a black hole binary. They are described in detail by Remillard (2005) and references therein.

Thermal state. If a source is in the thermal or “high/soft” state, the powerlaw continuum is very steep. The spectrum is dominated by the soft, thermal X-rays which account for the major part of the unabsorbed source flux. The normalization of the soft component may allow for inferences on the inner radius of the accretion disk and thus also on the black hole spin. However, source distance and inclination and, for the spin, the black hole mass have to be known exactly and there still are dependencies to the kind of disk model that was used. Hence, only vague estimates can be made. In the thermal state, no radio jet is detected.

Hard state. The hard, or “low/hard” state is generally associated with steady radio jets. The powerlaw continuum is flat with photon indices below 2. A disk can be detected only marginally and in a cool, extended shape, or it is not detected at all. This is the state that most sources can mainly be seen in.

Steep Powerlaw (SPL). The SPL is a redefinition of the former “very high” state. Although the powerlaw is very steep with photon indices above 2, the powerlaw flux starts to compete with the flux of the soft component. Sources in this state have very high luminosities approaching the Eddington limit and the powerlaw continuum extends to more than 800 keV. To reproduce such spectra, non-thermal Comptonization mechanisms have to be taken into account.

3.2. Hardness-Intensity Diagrams

Of course, a source is not in a single state of these three for all its life but there are state transitions. As the different states are mostly described by the spectral hardness and the luminosity of the source, it is obvious to investigate spectral evolutions in terms of these two quantities. Astronomers prefer the hardness-intensity diagram that shows the spectral hardness on the x -axis (increasing to the right, i.e. soft sources can be found on the left side, hard ones on the right) and the X-ray intensity on the y -axis (increasing to the top, i.e. dim sources are on the bottom, bright ones on the top).

In this diagram, Fender et al. (2004) have shown a unified model for the disk-jet coupling in black hole X-ray binaries. It is presented in Fig. 3.1. The upper, central panel shows a schematic HID, the black arrows indicating the way of a source that is going into an outburst and back again to quiescence. States are indicated as HS (high/soft state), VHS/IS (very high/intermediate state) and LS (low/hard state). In the bottom panel, the evolution of the jet Lorentz factor and the inner radius of the accretion disk during the outburst are shown. Schematic drawings on the right and left side of the panels illustrate the source geometry, blue color referring to the jet, yellow color to the corona and red color to the accretion disk.

The different stages a source undergoes in outburst, after Fender et al. (2004), are described according to the numbers in Fig. 3.1:

- (i) Starting at low luminosities and hard spectral indices, the source produces a steady jet. This stage can also extend farther down to near-quiescence.
- (ii) From stage (i) to stage (ii), luminosity increases while the spectral hardness as well as

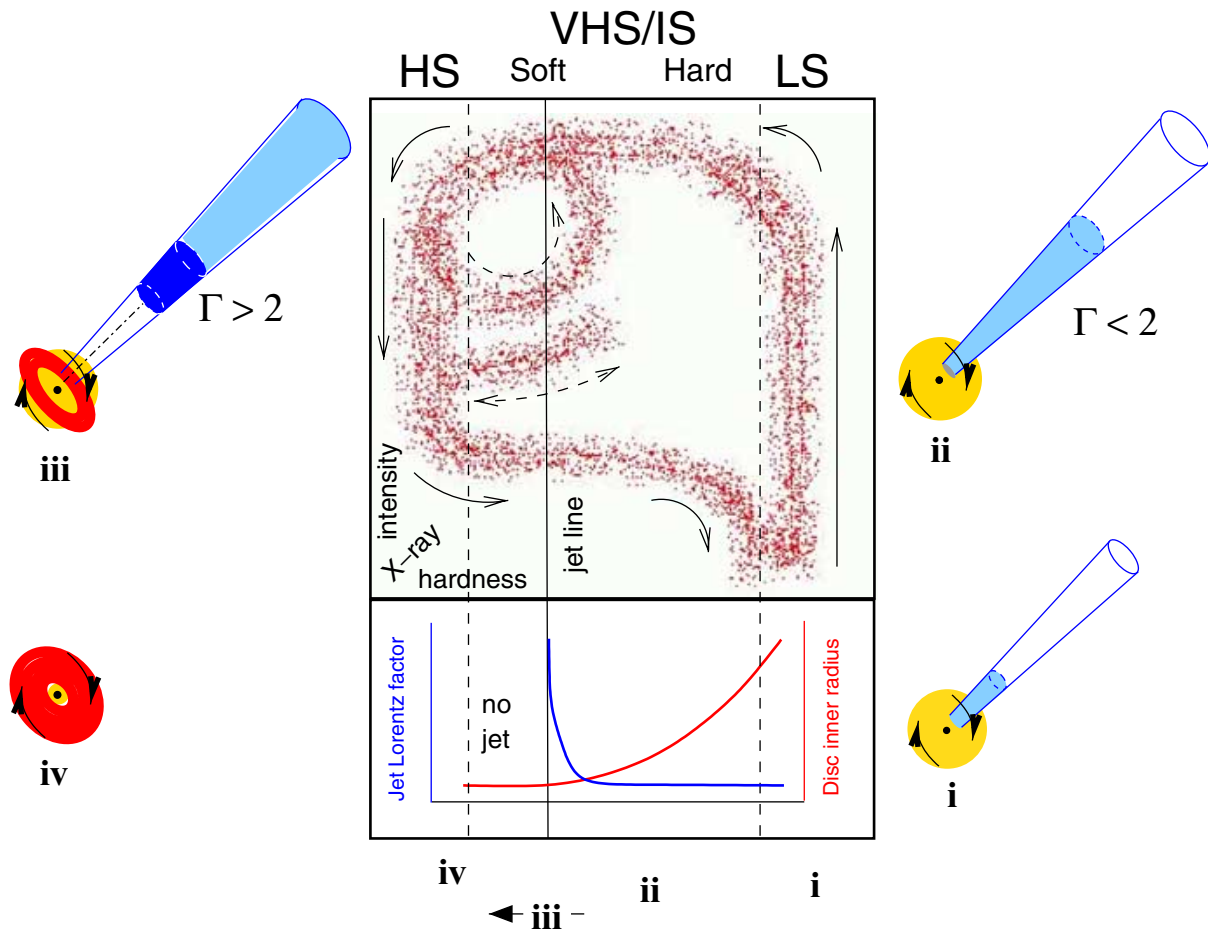

Figure 3.1.: Schematic drawing of the disk-jet coupling model; Fender et al. (2004), Fig. 7

the bulk Lorentz factor of the jet remain almost unchanged. After a peak in the LS, the spectrum finally softens and the motion of the source in the HID makes a left turn toward the VHS.

- (iii) During its horizontal motion in the HID, the source approaches the “jet line”, usually located close to the luminosity peak of the VHS. This jet line marks the border between jet-producing stages and those without jet. Now the jet undergoes significant changes, especially in its velocity: The bulk Lorentz factor increases rapidly. An internal shock wave in the jet is generated and propagated through the slower moving, more distant parts of the jet.
- (iv) As the jet is now physically decoupled from its engine, in the soft part of the VHS only the fading optically thin emission from the shock is observed.

Usually, after such an outburst, the source drops again in luminosity and, after more or less excursions or loops (dashed lines in Fig. 3.1) becomes harder again to return to its initial state. Again the jet line is crossed, the jet re-forms, but as there is no slower moving material in front of it, no further shocks are produced.

Fender et al. (2004) and references therein suggest possible physical mechanisms behind that scheme. As long as the source is in dim states, the jet could be powered by a modification of the Blandford/Payne mechanism (Blandford & Payne, 1982). Here, one has to consider frame dragging near a rotating black hole (Punsly & Coroniti, 1990). Similar to the Blandford/Znajek mechanism (Blandford & Znajek, 1977) that could work for a short time during phases of high accretion rates, the modified Blandford/Payne mechanism is able to extract rotation energy of spinning black hole and accelerates particles in bipolar outflows along the magnetic field lines of the black hole. However, there are still lots of caveats and open questions in this field.

3.3. The “own way” of GRS 1758–258

Hardness-intensity diagrams as described above were also produced for GRS 1758–258. The hardness ratio was calculated by dividing the high energy flux by the low energetic one. Thus,

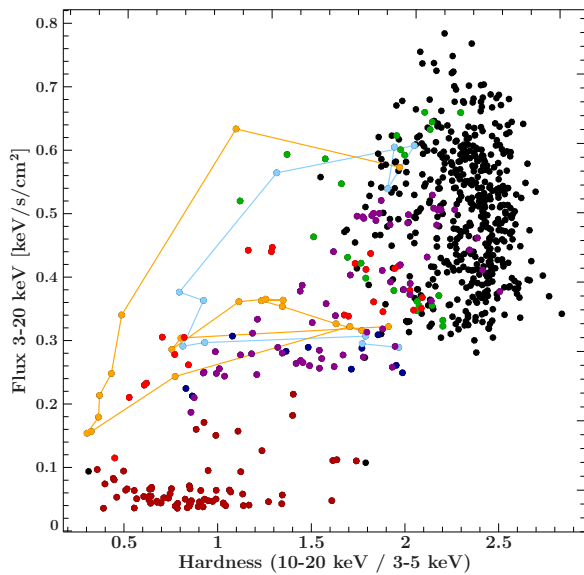

(a) HID of the *RXTE* data color-coding according to Fig. 2.5. For two soft states, tracks are shown.

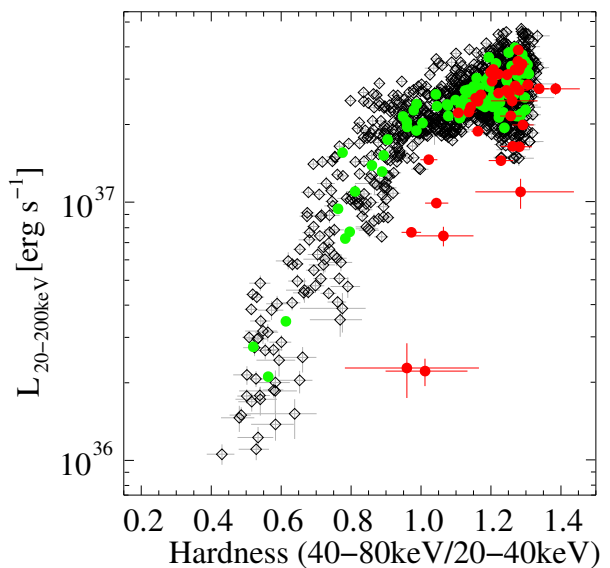

(b) HID from *INTEGRAL* monitoring of GRS 1758–258 from 2003 to 2009 (red: monthly binning), compared to the HID from *RXTE* monitoring of Cyg X-1 from 1998 to 2010 (black: individual points, green: monthly binning).

larger numbers correspond to harder spectra, smaller numbers to softer spectra.

In the *RXTE* monitoring campaign spectra, the high energy flux was taken from 10 keV to 20 keV, the lower energy flux from 3 keV to 5 keV. Plotted against the 3 – 20 keV flux, the resulting HID (Fig. 3.2(a)) seems somewhat different from the model described above:

The HID shows a clear hysteresis for hard and soft state (absorbed) fluxes, as expected from the model. However, there is no indication at all for a rise in the hard state from quiescence. During the most extreme soft state the 3 – 20 keV flux is clearly below the lowest hard state flux, with no full return to the hard branch observed down to near-quiescence. GRS 1758–258 seems to somehow short-cut the upper left part of the usual “q”-shaped HID and also does not show any dim hard states. This peculiar behavior has not yet been observed for any other source.

Results from spectral fits to 2003–2009 *INTEGRAL* monitoring data of GRS 1758–258 (Lohfink et al., 2011) allow to extend the HID studies to higher energies, where also data of Cyg X-1 exist (Fig. 3.2(b)). As expected, neither source shows hysteresis for energies above 20 keV, i.e., in an energy range where only one, namely the hard, spectral component dominates.

Overall, the tracks of GRS 1758–258 in both HIDs are consistent with a persistent hard state source with occasional softening due to a temporary decrease in the mass accretion rate as suggested by Smith et al. (2002). The hard state HIDs of both sources show a remarkably similar range of hardnesses. Assuming a distance of 1.9 kpc for Cyg X-1 as recently determined from radio parallax (Reid et al., 2011) and dust scattering halo measurements (Xiang et al., 2011), the > 20 keV luminosities would be similar if GRS 1758–258 had a distance of 6.4 kpc. It has to be noted, however, that while the decay towards softer, lower luminosity states is quantitatively similar in both sources as well, the luminosity of GRS 1758–258 has dropped more severely at a given hardness level than that of Cyg X-1.

There were things he stretched, but mainly
he told the truth.

(Mark Twain, “*The Adventures of
Huckleberry Finn*”)

4. Conclusions and Outlook

Seen as the little brothers of AGN, powerful objects far away from the earth and up to now only poorly understood, microquasars, galactic sources such as GRS 1758–258 that show the same behavior as their extragalactic equivalents but on shorter timescales, are one of the most interesting kinds of sources to observe. They allow astronomers to study unknown behavior and entirely new mechanisms. In this context, monitoring data of GRS 1758–258 were analyzed in this work.

The analysis of the 1996–2007 *RXTE* data reveals many details about the long-term behavior of the source. Typical hard state fluxes after taking into account the Galactic ridge X-ray emission are $0.2 - 0.4 \text{ keV s}^{-1} \text{ cm}^{-2}$. The spectra can be well described with an absorbed powerlaw with a photon index of 1.5–3. There are indications for a possible detection of an additional weak iron $K\alpha$ line.

During the monitoring, there are seven occurrences of soft states with photon indices above 2. These states are most likely due to a decrease in mass accretion rate, though the processes that drive changes in the accretion flow around the black hole are not understood yet (Belloni, 2010). During the soft states, a marginal disk detection with $kT_{in} \sim 400 - 700 \text{ eV}$ can be seen.

The $< 20 \text{ keV}$ HID shows hysteresis with no full return to the hard branch observed down to near-quiescence. The $> 20 \text{ keV}$ HID shows the same hard state luminosity and hardness as Cyg X-1 but a different decay. New hard X-ray observations by *INTEGRAL* as well as a comparison of the $< 20 \text{ keV}$ HID with the one of Cyg X-1 (using data from the long-term monitoring observations with *RXTE* to get the same energy range) will hopefully bring more information on the strange behavior of GRS 1758–258 in the HID and maybe will help to understand the difficult mechanisms of accretion.

The next steps will also include an analysis of the monitoring campaign light curves of GRS 1758–258. Using the algorithm of Jeffrey D. Scargle (Scargle, 1982; Horne & Baliunas, 1986; Press & Rybicki, 1989) that is able to detect periodic signals in unevenly spaced observation times, hopefully it will be possible to solve the question of the unknown optical companion in the system by confining its orbital parameters.

A. Appendix

Table A.1.: *Background observations that were added up*

Obs-ID	t_{start} [yyyy-mm-dd]	Exposure [ks]	α [$^{\circ}$]	δ [$^{\circ}$]
40097-09-01-00	1999-08-03	2.928	271.3620	-24.5720
40097-09-02-00	1999-08-11	1.136	271.3620	-24.5720
40097-09-02-01	1999-08-12	1.728	271.3620	-24.5720
40097-09-02-02	1999-08-12	1.744	271.3620	-24.5720
40097-09-02-03	1999-08-12	1.808	271.3620	-24.5720
40097-09-03-00	1999-08-16	1.200	271.3620	-24.5720
40097-09-04-00	1999-10-15	2.832	271.3620	-24.5720

Table A.2.: Best fit parameters for each spectrum. For detailed info see text.

ObsID	t_{start}	Exposure [s]	Flux [keV / cm ²]	Powerlaw norm	Powerlaw Γ	Disk norm	Disk Temperature [keV]	Gauss area photons/s/cm ²	χ^2	Degrees of freedom
10231-04-30-00	1996-10-16, 15:11:27	1328.0	0.398 ± 0.007	0.126 ± 0.008	1.75 ± 0.03	-	-	(0.8 ± 0.3) × 10 ⁻³	41.71	33
10231-04-31-00	1996-09-07, 04:25:45	1632.0	0.380 ± 0.006	0.10 ± 0.00	1.64 ^{+0.01} _{-0.13}	-	-	(0.64 ± 0.20) × 10 ⁻³	26.65	37
10231-04-32-00	1996-08-11, 13:44:13	1344.0	0.420 ^{+0.007} _{-0.006}	0.10 ± 0.01	1.63 ^{+0.06} _{-0.14}	-	-	(0.7 ± 0.3) × 10 ⁻³	51.66	34
10231-04-33-00	1996-07-12, 13:49:30	1296.0	0.396 ± 0.007	0.09 ± 0.02	1.59 ^{+0.03} _{-0.13}	-	-	(0.6 ± 0.3) × 10 ⁻³	25.40	37
10231-04-34-00	1996-06-09, 23:01:19	1408.0	0.361 ^{+0.007} _{-0.006}	0.087 ^{+0.009} _{-0.010}	1.62 ± 0.05	-	-	(0.7 ^{+0.3} _{-0.2}) × 10 ⁻³	32.53	35
10231-04-35-00	1996-05-15, 09:47:11	1248.0	0.357 ^{+0.007} _{-0.006}	0.09 ± 0.01	1.62 ^{+0.05} _{-0.14}	-	-	(0.4 ± 0.3) × 10 ⁻³	25.10	36
10231-04-36-00	1996-04-16, 12:03:04	1856.0	0.411 ± 0.006	0.11 ± 0.01	1.66 ^{+0.03} _{-0.11}	-	-	(0.4 ± 0.2) × 10 ⁻³	32.38	37
10231-04-37-00	1996-03-14, 12:22:23	256.0	0.425 ± 0.016	0.085 ± 0.012	1.53 ± 0.07	-	-	(0.5 ^{+0.6} _{-0.3}) × 10 ⁻³	29.33	35
10231-04-38-00	1996-03-02, 05:29:19	816.0	0.399 ± 0.005	0.077 ± 0.006	1.52 ± 0.04	-	-	(0.6 ± 0.3) × 10 ⁻³	27.31	44
10231-04-39-00	1996-02-02, 16:10:16	1472.0	0.340 ± 0.006	0.061 ± 0.005	1.48 ^{+0.04} _{-0.05}	-	-	(0.6 ± 0.2) × 10 ⁻³	54.57	45
10232-02-01-00	1996-08-05, 10:28:04	16624.0	0.386 ± 0.002	0.0938 ^{+0.0018} _{-0.0017}	1.620 ± 0.010	-	-	(0.65 ± 0.07) × 10 ⁻³	45.85	41
10232-02-01-01	1996-08-04, 20:33:19	3312.0	0.383 ± 0.005	0.07 ± 0.02	1.51 ± 0.10	-	-	(0.62 ± 0.17) × 10 ⁻³	29.21	40
10232-02-01-02	1996-08-03, 05:59:43	9504.0	0.383 ± 0.003	0.095 ± 0.003	1.63 ^{+0.02} _{-0.07}	-	-	(0.63 ^{+0.11} _{-0.10}) × 10 ⁻³	33.62	41
20166-02-01-00	1996-11-02, 16:51:16	1536.0	0.338 ± 0.006	0.07 ± 0.02	1.58 ^{+0.09} _{-0.15}	-	-	(0.8 ± 0.2) × 10 ⁻³	23.68	37
20166-02-02-00	1996-11-12, 10:16:16	1408.0	0.323 ± 0.007	0.080 ± 0.006	1.63 ± 0.04	-	-	(0.6 ± 0.2) × 10 ⁻³	16.72	35
20166-02-03-00	1997-01-22, 22:55:20	1344.0	0.411 ± 0.007	0.10 ± 0.01	1.85 ^{+0.04} _{-0.16}	-	-	(0.6 ± 0.3) × 10 ⁻³	31.07	36
20166-02-04-00	1997-01-29, 19:48:15	1280.0	0.363 ± 0.007	0.11 ± 0.01	1.73 ^{+0.04} _{-0.18}	-	-	(0.4 ^{+0.3} _{-0.2}) × 10 ⁻³	25.98	35
20166-02-05-00	1997-02-05, 16:39:14	1328.0	0.321 ± 0.007	0.08 ± 0.01	1.62 ^{+0.06} _{-0.16}	-	-	(0.4 ± 0.3) × 10 ⁻³	25.21	33
20166-02-06-00	1997-02-09, 18:07:15	1472.0	0.325 ± 0.005	0.09 ± 0.03	1.67 ^{+0.07} _{-0.17}	-	-	(0.6 ± 0.2) × 10 ⁻³	34.27	36
20166-02-07-00	1997-02-17, 08:55:14	1184.0	0.340 ± 0.007	0.09 ± 0.02	1.68 ^{+0.07} _{-0.18}	-	-	(0.6 ± 0.3) × 10 ⁻³	31.83	34
20166-02-08-00	1997-02-25, 07:14:13	1472.0	0.361 ± 0.006	0.10 ± 0.01	1.69 ^{+0.04} _{-0.13}	-	-	(0.8 ± 0.2) × 10 ⁻³	31.56	37
20166-02-09-00	1997-03-06, 04:17:13	1376.0	0.347 ± 0.006	0.098 ± 0.009	1.69 ^{+0.05} _{-0.14}	-	-	(0.7 ± 0.2) × 10 ⁻³	33.06	36
20166-02-10-00	1997-03-10, 00:34:12	1440.0	0.367 ± 0.006	0.10 ± 0.01	1.69 ^{+0.05} _{-0.09}	-	-	(0.8 ± 0.3) × 10 ⁻³	26.88	36
20166-02-11-00	1997-03-18, 18:46:15	1488.0	0.297 ± 0.006	0.06 ± 0.02	1.53 ^{+0.13} _{-0.05}	-	-	(0.6 ± 0.2) × 10 ⁻³	23.57	35
20166-02-12-00	1997-03-26, 16:42:39	1584.0	0.278 ± 0.005	0.07 ± 0.01	1.61 ^{+0.05} _{-0.16}	-	-	(0.4 ± 0.2) × 10 ⁻³	33.74	35
20166-02-13-00	1997-04-03, 12:34:14	1344.0	0.303 ± 0.006	0.07 ± 0.01	1.59 ^{+0.04} _{-0.15}	-	-	(0.3 ± 0.2) × 10 ⁻³	34.35	35
20166-02-14-00	1997-04-11, 09:18:15	1472.0	0.367 ± 0.006	0.087 ± 0.006	1.61 ± 0.03	-	-	(0.7 ± 0.2) × 10 ⁻³	25.14	36
20166-02-15-00	1997-04-16, 02:47:59	1456.0	0.343 ± 0.006	0.087 ± 0.006	1.64 ± 0.03	-	-	(0.6 ± 0.2) × 10 ⁻³	37.14	36
20166-02-16-00	1997-04-24, 01:42:16	1392.0	0.360 ± 0.007	0.088 ± 0.006	1.62 ± 0.03	-	-	(0.5 ± 0.2) × 10 ⁻³	33.94	36
20166-02-17-00	1997-04-28, 21:59:15	1424.0	0.371 ± 0.006	0.08 ± 0.02	1.58 ^{+0.07} _{-0.14}	-	-	(0.8 ± 0.2) × 10 ⁻³	28.63	37
20166-02-18-00	1997-05-08, 17:45:28	1600.0	0.369 ± 0.006	0.08 ± 0.01	1.59 ^{+0.05} _{-0.14}	-	-	(0.5 ± 0.2) × 10 ⁻³	29.01	37
20166-02-19-00	1997-05-14, 16:09:46	1424.0	0.428 ± 0.007	0.09 ± 0.02	1.57 ^{+0.10} _{-0.06}	-	-	(0.9 ± 0.3) × 10 ⁻³	35.10	39
20166-02-20-00	1997-05-20, 13:12:05	1104.0	0.407 ± 0.007	0.10 ± 0.03	1.60 ^{+0.08} _{-0.15}	-	-	(0.7 ± 0.3) × 10 ⁻³	42.82	36
20166-02-21-00	1997-05-26, 08:14:36	1376.0	0.405 ± 0.007	0.11 ± 0.03	1.69 ^{+0.01} _{-0.03}	-	-	(0.7 ± 0.2) × 10 ⁻³	26.11	37
20166-02-22-00	1997-06-05, 05:28:47	1088.0	0.390 ± 0.007	0.100 ± 0.007	1.65 ± 0.04	-	-	(0.4 ± 0.3) × 10 ⁻³	24.65	35
20166-02-23-00	1997-06-10, 00:42:13	1264.0	0.377 ± 0.007	0.09 ± 0.01	1.59 ^{+0.04} _{-0.12}	-	-	(0.3 ± 0.3) × 10 ⁻³	29.51	37
20166-02-24-00	1997-06-19, 16:45:51	1360.0	0.383 ± 0.007	0.09 ± 0.02	1.61 ^{+0.11} _{-0.15}	-	-	(0.7 ± 0.3) × 10 ⁻³	35.44	35
20166-02-25-00	1997-06-27, 13:29:54	1104.0	0.329 ± 0.007	0.07 ± 0.02	1.55 ^{+0.15} _{-0.18}	-	-	(0.5 ± 0.3) × 10 ⁻³	25.39	33
20166-02-26-00	1997-07-04, 08:44:19	1216.0	0.335 ± 0.007	0.070 ± 0.006	1.55 ± 0.04	-	-	(0.3 ± 0.2) × 10 ⁻³	34.62	35
20166-02-27-00	1997-07-09, 06:45:21	1424.0	0.317 ± 0.006	0.07 ± 0.01	1.56 ^{+0.08} _{-0.18}	-	-	(0.6 ^{+0.3} _{-0.2}) × 10 ⁻³	30.98	35

ObsID	t _{start}	Exposure [s]	Flux [keV/s/cm ²]	Powerlaw norm	Powerlaw Γ	Disk norm	Disk Temperature [keV]	Gauss area photons/s/cm ²	χ^2	Degrees of freedom
20166-02-28-00	1997-07-17, 02:35:30	1328.0	0.339 ^{+0.007} _{-0.006}	0.074 ^{+0.006} _{-0.005}	1.57 ± 0.04	-	-	(0.4 ± 0.2) × 10 ⁻³	24.62	36
20166-02-29-00	1997-07-24, 10:35:41	1744.0	0.358 ± 0.006	0.083 ± 0.006	1.60 ^{+0.04} _{-0.10}	-	-	(0.6 ± 0.2) × 10 ⁻³	18.68	37
20166-02-30-00	1997-07-28, 20:26:08	1328.0	0.374 ^{+0.007} _{-0.019}	0.087 ± 0.006	1.60 ± 0.04	-	-	(0.6 ± 0.2) × 10 ⁻³	29.72	36
20166-02-31-00	1997-08-03, 15:30:22	1344.0	0.380 ^{+0.007} _{-0.007}	0.08 ± 0.007	1.56 ^{+0.05} _{-0.12}	-	-	(0.5 ± 0.3) × 10 ⁻³	38.43	36
20166-02-32-00	1997-08-12, 17:24:18	1232.0	0.380 ± 0.008	0.08 ± 0.01	1.55 ^{+0.05} _{-0.19}	-	-	(0.7 ± 0.3) × 10 ⁻³	31.51	36
20166-02-33-00	1997-08-19, 12:38:07	1296.0	0.394 ± 0.007	0.085 ± 0.006	1.56 ± 0.03	-	-	(0.6 ± 0.2) × 10 ⁻³	23.46	35
20166-02-34-00	1997-08-27, 09:21:17	1488.0	0.365 ± 0.007	0.081 ± 0.001	1.58 ^{+0.04} _{-0.06}	-	-	(0.6 ± 0.2) × 10 ⁻³	35.84	35
20166-02-35-00	1997-09-03, 08:08:53	592.0	0.390 ± 0.011	0.07 ± 0.01	1.5 ± 0.1	-	-	(0.9 ± 0.4) × 10 ⁻³	36.36	32
20166-02-35-01	1997-09-03, 06:09:17	592.0	0.392 ^{+0.011} _{-0.010}	0.07 ± 0.03	1.48 ^{+0.11} _{-0.20}	-	-	(0.8 ± 0.4) × 10 ⁻³	22.14	32
20166-02-36-00	1997-09-11, 20:40:31	1664.0	0.382 ± 0.007	0.08 ± 0.01	1.55 ^{+0.05} _{-0.14}	-	-	(0.6 ± 0.2) × 10 ⁻³	42.12	37
20166-02-37-00	1997-09-18, 21:00:17	1312.0	0.401 ± 0.007	0.09 ± 0.02	1.61 ± 0.03	-	-	(0.6 ± 0.3) × 10 ⁻³	27.43	35
20166-02-38-00	1997-09-25, 19:30:56	1264.0	0.364 ± 0.007	0.06 ± 0.02	1.45 ± 0.13	-	-	(0.7 ± 0.3) × 10 ⁻³	33.80	34
20166-02-39-00	1997-09-30, 16:11:16	1488.0	0.368 ± 0.007	0.09 ± 0.01	1.61 ^{+0.04} _{-0.15}	-	-	(0.7 ± 0.3) × 10 ⁻³	22.01	37
20166-02-40-00	1997-10-04, 09:58:39	1552.0	0.365 ± 0.007	0.065 ± 0.008	1.48 ^{+0.06} _{-0.13}	-	-	(0.4 ± 0.3) × 10 ⁻³	26.42	37
20166-02-41-00	1997-10-13, 06:44:31	1472.0	0.379 ± 0.006	0.080 ± 0.005	1.55 ± 0.03	-	-	(0.4 ± 0.2) × 10 ⁻³	31.49	37
20166-02-42-00	1997-10-20, 02:01:16	1472.0	0.370 ± 0.007	0.08 ± 0.00	1.57 ^{+0.04} _{-0.03}	-	-	(0.6 ± 0.3) × 10 ⁻³	18.12	37
20166-02-43-00	1997-10-27, 22:54:17	1376.0	0.378 ± 0.007	0.07 ± 0.02	1.50 ^{+0.09} _{-0.14}	-	-	(0.6 ± 0.3) × 10 ⁻³	23.33	37
20166-02-44-00	1997-11-04, 21:23:17	1488.0	0.419 ± 0.007	0.09 ± 0.00	1.57 ^{+0.03} _{-0.10}	-	-	(0.4 ± 0.3) × 10 ⁻³	31.39	37
20166-02-45-00	1997-11-11, 16:46:31	1296.0	0.388 ± 0.007	0.091 ± 0.006	1.60 ± 0.03	-	-	(0.7 ± 0.3) × 10 ⁻³	35.28	36
20166-02-46-00	1997-11-17, 11:52:43	1456.0	0.456 ± 0.006	0.09 ± 0.01	1.52 ^{+0.07} _{-0.12}	-	-	(0.9 ± 0.3) × 10 ⁻³	42.15	38
20166-02-47-00	1999-01-31, 03:21:29	1328.0	0.375 ± 0.007	0.0839 ± 0.0011	1.58 ^{+0.01} _{-0.04}	-	-	(0.6 ± 0.2) × 10 ⁻³	24.86	37
20166-02-48-00	1999-02-07, 22:25:17	1440.0	0.457 ± 0.007	0.10 ± 0.01	1.59 ^{+0.05} _{-0.02}	-	-	(0.7 ± 0.2) × 10 ⁻³	29.99	39
20166-02-49-00	1999-02-14, 20:44:17	1376.0	0.439 ± 0.006	0.10 ± 0.03	1.61 ^{+0.02} _{-0.13}	-	-	(0.5 ± 0.3) × 10 ⁻³	28.80	39
20166-02-50-00	1999-02-21, 15:16:59	1472.0	0.501 ± 0.007	0.140 ± 0.007	1.69 ± 0.03	-	-	(0.8 ± 0.3) × 10 ⁻³	30.31	39
20166-02-51-00	1999-02-28, 09:18:41	1456.0	0.526 ± 0.007	0.152 ± 0.007	1.70 ± 0.02	-	-	(0.7 ± 0.3) × 10 ⁻³	35.32	39
20166-02-52-00	1999-03-08, 04:31:16	1648.0	0.482 ± 0.007	0.15 ± 0.02	1.72 ^{+0.05} _{-0.12}	-	-	(0.8 ± 0.3) × 10 ⁻³	45.35	39
30149-01-01-00	1998-01-22, 23:36:52	1440.0	0.468 ± 0.007	0.119 ± 0.006	1.64 ± 0.03	-	-	(0.6 ± 0.2) × 10 ⁻³	39.35	38
30149-01-02-00	1998-01-29, 02:49:15	1312.0	0.536 ± 0.007	0.14 ± 0.01	1.65 ^{+0.03} _{-0.07}	-	-	(0.7 ± 0.3) × 10 ⁻³	35.33	39
30149-01-03-00	1998-02-05, 20:33:16	1616.0	0.523 ± 0.007	0.135 ± 0.006	1.65 ± 0.02	-	-	(0.7 ± 0.2) × 10 ⁻³	29.05	39
30149-01-04-00	1998-02-12, 17:28:16	1312.0	0.467 ± 0.008	0.120 ± 0.007	1.65 ± 0.03	-	-	(0.8 ± 0.3) × 10 ⁻³	34.62	38
30149-01-05-00	1998-02-19, 15:52:16	1456.0	0.512 ± 0.007	0.142 ± 0.007	1.68 ± 0.03	-	-	(0.8 ± 0.3) × 10 ⁻³	27.80	39
30149-01-06-00	1998-02-26, 12:35:16	1168.0	0.465 ± 0.008	0.11 ± 0.04	1.63 ^{+0.13} _{-0.15}	-	-	(0.7 ± 0.3) × 10 ⁻³	28.68	38
30149-01-07-00	1998-03-04, 15:50:15	1040.0	0.464 ± 0.008	0.172 ± 0.011	1.81 ± 0.03	-	-	(0.4 ± 0.3) × 10 ⁻³	40.11	37
30149-01-08-00	1998-03-12, 00:05:15	1568.0	0.450 ± 0.007	0.18 ± 0.01	1.86 ^{+0.03} _{-0.07}	-	-	(0.6 ± 0.3) × 10 ⁻³	22.48	37
30149-01-09-00	1998-03-18, 22:34:15	1360.0	0.393 ± 0.007	0.12 ± 0.03	1.72 ^{+0.09} _{-0.16}	-	-	(0.4 ± 0.3) × 10 ⁻³	32.28	36
30149-01-10-00	1998-03-27, 05:01:48	400.0	0.384 ± 0.012	0.14 ± 0.03	1.8 ± 0.1	-	-	(0.4 ± 0.5) × 10 ⁻³	23.20	28
30149-01-11-00	1998-04-03, 17:49:16	1376.0	0.354 ± 0.006	0.10 ± 0.01	1.71 ± 0.03	-	-	(0.7 ± 0.2) × 10 ⁻³	36.42	36
30149-01-12-00	1998-04-09, 14:40:54	1296.0	0.320 ± 0.007	0.08 ± 0.02	1.66 ^{+0.08} _{-0.18}	-	-	(0.3 ± 0.2) × 10 ⁻³	21.13	35
30149-01-13-00	1998-04-18, 09:47:16	1152.0	0.334 ± 0.007	0.08 ± 0.01	1.6 ± 0.1	-	-	(0.5 ± 0.3) × 10 ⁻³	24.41	34

ObsID	t _{start}	Exposure [s]	Flux [keV/s/cm ²]	Powerlaw norm	Powerlaw Γ	Disk norm	Disk Temperature [keV]	Gauss area photons/s/cm ²	χ^2	Degrees of freedom
30149-01-14-00	1998-04-28, 21:14:19	1408.0	0.323 ± 0.006	0.082 ^{+0.009} _{-0.016}	1.64 ^{+0.05} _{-0.09}	-	-	(0.3 ± 0.2) × 10 ⁻³	25.28	36
30149-01-15-00	1998-05-07, 19:33:27	1424.0	0.336 ± 0.006	0.08 ^{+0.01} _{-0.03}	1.61 ^{+0.04} _{-0.16}	-	-	(0.6 ± 0.2) × 10 ⁻³	34.01	36
30149-01-16-00	1998-05-14, 17:36:01	1440.0	0.316 ± 0.006	0.06 ^{+0.01} _{-0.01}	1.55 ^{+0.09} _{-0.16}	-	-	(0.6 ± 0.2) × 10 ⁻³	25.95	35
30149-01-17-00	1998-05-20, 14:21:06	1552.0	0.329 ^{+0.006} _{-0.005}	0.08 ^{+0.01} _{-0.04}	1.6 ^{+0.3} _{-0.3}	-	-	(0.6 ^{+0.3} _{-0.2}) × 10 ⁻³	35.77	36
30149-01-18-00	1998-05-28, 19:46:54	1088.0	0.349 ± 0.007	0.10 ^{+0.01} _{-0.04}	1.7 ^{+0.0} _{-0.2}	-	-	(0.8 ± 0.3) × 10 ⁻³	21.98	35
30149-01-19-00	1998-06-02, 13:14:49	1712.0	0.355 ^{+0.006} _{-0.005}	0.09 ^{+0.01} _{-0.03}	1.66 ^{+0.03} _{-0.17}	-	-	(0.5 ± 0.2) × 10 ⁻³	40.59	37
30149-01-20-00	1998-06-10, 03:13:06	1360.0	0.400 ^{+0.005} _{-0.006}	0.094 ± 0.006	1.60 ± 0.03	-	-	(0.5 ± 0.2) × 10 ⁻³	24.65	37
30149-01-21-00	1998-06-16, 06:31:13	1712.0	0.440 ± 0.006	0.11 ^{+0.01} _{-0.03}	1.64 ^{+0.04} _{-0.12}	-	-	(0.7 ^{+0.3} _{-0.2}) × 10 ⁻³	27.33	38
30149-01-22-00	1998-06-23, 00:47:27	1040.0	0.434 ^{+0.009} _{-0.008}	0.113 ^{+0.009} _{-0.019}	1.65 ^{+0.04} _{-0.08}	-	-	(0.3 ± 0.3) × 10 ⁻³	27.96	36
30149-01-23-00	1998-06-30, 16:43:15	1280.0	0.456 ^{+0.008} _{-0.007}	0.12 ^{+0.02} _{-0.04}	1.66 ^{+0.07} _{-0.15}	-	-	(0.8 ± 0.3) × 10 ⁻³	25.57	36
30149-01-24-00	1998-07-08, 13:27:59	1456.0	0.421 ^{+0.007} _{-0.006}	0.09 ± 0.03	1.58 ^{+0.14} _{-0.17}	-	-	(0.8 ± 0.3) × 10 ⁻³	32.72	38
30149-01-25-00	1998-07-14, 08:42:23	1296.0	0.444 ^{+0.008} _{-0.007}	0.11 ^{+0.02} _{-0.03}	1.65 ^{+0.07} _{-0.13}	-	-	(0.7 ± 0.3) × 10 ⁻³	38.34	36
30149-01-26-00	1998-07-19, 03:58:39	1088.0	0.432 ^{+0.008} _{-0.007}	0.108 ^{+0.008} _{-0.007}	1.63 ^{+0.04} _{-0.03}	-	-	(0.5 ± 0.3) × 10 ⁻³	28.26	37
30149-01-27-00	1998-07-25, 03:44:38	1680.0	0.389 ^{+0.006} _{-0.007}	0.07 ± 0.02	1.51 ^{+0.14} _{-0.14}	-	-	(0.7 ^{+0.3} _{-0.2}) × 10 ⁻³	29.37	38
30149-01-28-00	1998-07-31, 23:15:48	1168.0	0.412 ^{+0.007} _{-0.006}	0.10 ^{+0.01} _{-0.03}	1.63 ^{+0.05} _{-0.16}	-	-	(0.4 ± 0.3) × 10 ⁻³	25.38	37
30149-01-29-00	1998-08-09, 21:15:19	1360.0	0.446 ^{+0.008} _{-0.007}	0.104 ± 0.006	1.60 ± 0.03	-	-	(0.4 ± 0.3) × 10 ⁻³	34.09	37
30149-01-30-00	1998-08-14, 11:59:17	1600.0	0.416 ^{+0.006} _{-0.006}	0.098 ^{+0.008} _{-0.018}	1.61 ^{+0.04} _{-0.04}	-	-	(0.7 ± 0.3) × 10 ⁻³	34.71	38
30149-01-31-00	1998-08-21, 16:50:17	1360.0	0.454 ^{+0.008} _{-0.007}	0.100 ± 0.006	1.57 ± 0.03	-	-	(0.6 ± 0.3) × 10 ⁻³	33.13	38
30149-01-32-00	1998-08-29, 08:51:17	1248.0	0.405 ^{+0.008} _{-0.007}	0.09 ^{+0.01} _{-0.02}	1.59 ^{+0.04} _{-0.12}	-	-	(0.8 ± 0.3) × 10 ⁻³	33.10	37
30149-01-33-00	1998-09-04, 05:37:17	1296.0	0.372 ± 0.007	0.08 ^{+0.01} _{-0.03}	1.56 ^{+0.06} _{-0.16}	-	-	(0.5 ± 0.3) × 10 ⁻³	39.94	36
30149-01-34-00	1998-09-11, 05:36:17	1296.0	0.390 ± 0.008	0.08 ^{+0.01} _{-0.02}	1.53 ^{+0.06} _{-0.15}	-	-	(0.6 ± 0.3) × 10 ⁻³	26.24	37
30149-01-35-00	1998-09-24, 00:38:16	1296.0	0.371 ± 0.007	0.078 ^{+0.006} _{-0.007}	1.55 ± 0.04	-	-	(0.8 ± 0.3) × 10 ⁻³	35.76	35
30149-01-36-00	1998-09-30, 15:09:17	1488.0	0.412 ^{+0.007} _{-0.006}	0.090 ^{+0.016} _{-0.007}	1.57 ^{+0.04} _{-0.08}	-	-	(0.4 ± 0.3) × 10 ⁻³	42.59	37
30149-01-37-00	1998-10-03, 13:42:17	1344.0	0.410 ± 0.007	0.09 ^{+0.01} _{-0.03}	1.59 ^{+0.04} _{-0.15}	-	-	(0.6 ± 0.3) × 10 ⁻³	16.64	37
30149-01-38-00	1998-10-10, 07:15:16	1376.0	0.388 ^{+0.007} _{-0.006}	0.08 ^{+0.01} _{-0.02}	1.55 ^{+0.04} _{-0.12}	-	-	(0.5 ^{+0.3} _{-0.2}) × 10 ⁻³	45.49	38
30149-01-39-00	1999-01-23, 17:26:55	1408.0	0.408 ^{+0.007} _{-0.007}	0.097 ± 0.006	1.61 ± 0.03	-	-	(0.8 ± 0.2) × 10 ⁻³	21.99	37
30149-01-40-00	1998-10-23, 07:07:17	1568.0	0.455 ^{+0.006} _{-0.006}	0.104 ^{+0.001} _{-0.018}	1.59 ^{+0.03} _{-0.08}	-	-	(0.7 ± 0.3) × 10 ⁻³	35.73	38
30149-01-41-00	1998-10-30, 04:58:23	1424.0	0.424 ^{+0.007} _{-0.005}	0.094 ^{+0.006} _{-0.005}	1.58 ± 0.03	-	-	(0.6 ± 0.3) × 10 ⁻³	19.04	37
30149-01-42-00	1998-11-07, 18:12:16	1472.0	0.492 ^{+0.006} _{-0.006}	0.106 ^{+0.005} _{-0.011}	1.57 ± 0.04	-	-	(0.8 ± 0.3) × 10 ⁻³	22.68	39
30149-01-43-00	1998-11-13, 10:22:32	1264.0	0.451 ^{+0.008} _{-0.007}	0.10 ^{+0.01} _{-0.03}	1.57 ^{+0.04} _{-0.13}	-	-	(1.1 ± 0.3) × 10 ⁻³	27.71	38
30149-01-44-00	1998-11-21, 11:23:11	1440.0	0.518 ^{+0.008} _{-0.007}	0.11 ^{+0.02} _{-0.03}	1.55 ^{+0.09} _{-0.12}	-	-	(0.8 ± 0.3) × 10 ⁻³	33.58	40
30149-01-45-00	1999-03-14, 23:31:16	1360.0	0.491 ^{+0.007} _{-0.006}	0.18 ^{+0.03} _{-0.03}	1.82 ^{+0.12} _{-0.12}	-	-	(0.7 ± 0.3) × 10 ⁻³	35.85	37
30149-01-46-00	1999-03-21, 21:54:17	1536.0	0.485 ^{+0.007} _{-0.006}	0.17 ^{+0.02} _{-0.05}	1.79 ^{+0.06} _{-0.13}	-	-	(0.6 ± 0.3) × 10 ⁻³	40.56	38
30149-01-47-00	1999-03-28, 17:05:16	1152.0	0.436 ^{+0.007} _{-0.006}	0.200 ^{+0.013} _{-0.012}	1.92 ± 0.03	-	-	(0.8 ± 0.3) × 10 ⁻³	26.97	30
30149-01-48-00	1999-04-04, 20:03:17	1504.0	0.422 ± 0.006	0.10 ^{+0.01} _{-0.03}	1.64 ^{+0.12} _{-0.13}	-	-	(0.6 ^{+0.3} _{-0.2}) × 10 ⁻³	38.01	33
30149-01-49-00	1999-04-11, 11:57:17	1456.0	0.389 ± 0.006	0.12 ^{+0.02} _{-0.04}	1.76 ^{+0.16} _{-0.16}	-	-	(0.9 ^{+0.3} _{-0.2}) × 10 ⁻³	20.55	32
30149-01-50-00	1999-04-18, 13:19:17	1760.0	0.369 ^{+0.006} _{-0.005}	0.12 ^{+0.01} _{-0.03}	1.74 ^{+0.03} _{-0.12}	-	-	(0.6 ± 0.2) × 10 ⁻³	27.31	32
30149-01-51-00	1999-04-26, 01:41:38	1264.0	0.387 ^{+0.007} _{-0.006}	0.10 ± 0.03	1.68 ^{+0.10} _{-0.16}	-	-	(0.6 ± 0.3) × 10 ⁻³	31.72	32
30149-01-52-00	1999-05-01, 13:03:11	1392.0	0.359 ^{+0.006} _{-0.003}	0.1016 ± 0.0014	1.69 ^{+0.11} _{-0.11}	-	-	(0.7 ± 0.2) × 10 ⁻³	17.93	31
40097-03-01-00	1999-03-03, 07:14:28	12560.0	0.498 ^{+0.003} _{-0.002}	0.114 ^{+0.013} _{-0.011}	1.60 ± 0.04	-	-	(0.74 ± 0.09) × 10 ⁻³	43.06	41

ObsID	t _{start}	Exposure [s]	Flux [keV/s/cm ²]	Powerlaw norm	Powerlaw Γ	Disk norm	Disk Temperature [keV]	Gauss area photons/s/cm ²	χ^2	Degrees of freedom
40097-03-01-01	1999-03-04, 02:29:35	6672.0	0.502 ^{+0.004} _{-0.003}	0.137 ^{+0.006} _{-0.019}	1.67 ^{+0.02} _{-0.06}	-	-	(0.70 ± 0.14) × 10 ⁻³	34.72	41
40097-03-01-02	1999-03-04, 05:38:28	2896.0	0.501 ^{+0.005} _{-0.004}	0.13 ^{+0.02} _{-0.03}	1.66 ^{+0.05} _{-0.09}	-	-	(0.86 ^{+0.20} _{-0.19}) × 10 ⁻³	27.18	41
40097-03-01-03	1999-03-04, 05:43:36	2848.0	0.504 ^{+0.005} _{-0.004}	0.13 ± 0.02	1.65 ^{+0.07} _{-0.09}	-	-	(0.6 ± 0.2) × 10 ⁻³	44.47	41
40097-03-02-00	1999-03-07, 00:49:40	3200.0	0.478 ^{+0.005} _{-0.004}	0.13 ^{+0.01} _{-0.02}	1.68 ^{+0.03} _{-0.08}	-	-	(0.66 ^{+0.20} _{-0.18}) × 10 ⁻³	43.57	41
40097-03-02-01	1999-03-08, 21:37:19	2896.0	0.494 ^{+0.005} _{-0.004}	0.14 ^{+0.02} _{-0.03}	1.70 ^{+0.07} _{-0.08}	-	-	(0.58 ± 0.19) × 10 ⁻³	23.52	41
40097-04-01-00	1999-03-16, 22:00:54	4496.0	0.511 ^{+0.004} _{-0.003}	0.18 ^{+0.01} _{-0.01}	1.80 ^{+0.03} _{-0.03}	-	-	(0.66 ^{+0.19} _{-0.18}) × 10 ⁻³	41.81	41
40097-04-01-01	1999-03-18, 00:40:48	3296.0	0.499 ^{+0.005} _{-0.004}	0.176 ^{+0.009} _{-0.011}	1.80 ^{+0.02} _{-0.02}	-	-	(0.70 ± 0.18) × 10 ⁻³	45.63	41
40097-04-01-02	1999-03-18, 18:14:26	2944.0	0.494 ^{+0.005} _{-0.004}	0.19 ^{+0.00} _{-0.03}	1.82 ^{+0.02} _{-0.06}	-	-	(0.44 ± 0.19) × 10 ⁻³	39.40	41
40097-04-02-00	1999-03-19, 00:39:45	6592.0	0.496 ^{+0.003} _{-0.003}	0.18 ^{+0.03} _{-0.03}	1.81 ^{+0.07} _{-0.07}	-	-	(0.58 ± 0.13) × 10 ⁻³	30.89	41
40097-04-02-01	1999-03-19, 23:02:36	9856.0	0.491 ^{+0.003} _{-0.002}	0.19 ± 0.02	1.83 ^{+0.04} _{-0.06}	-	-	(0.70 ^{+0.12} _{-0.10}) × 10 ⁻³	46.80	41
40097-04-02-02	1999-03-20, 18:13:42	16192.0	0.488 ± 0.002	0.179 ^{+0.016} _{-0.018}	1.82 ± 0.04	-	-	(0.62 ± 0.08) × 10 ⁻³	43.67	41
40097-04-02-04	1999-03-23, 00:35:48	3280.0	0.478 ^{+0.005} _{-0.004}	0.165 ^{+0.008} _{-0.018}	1.78 ^{+0.05} _{-0.05}	-	-	(0.50 ± 0.18) × 10 ⁻³	41.18	35
40097-04-03-00	1999-08-20, 18:48:07	1792.0	0.246 ^{+0.006} _{-0.005}	0.19 ^{+0.03} _{-0.04}	2.21 ^{+0.08} _{-0.11}	(1.0 ^{+0.0} _{-0.3}) × 10 ³	0.47 ^{+0.15} _{-0.02}	(0.6 ± 0.2) × 10 ⁻³	21.23	24
40097-04-04-00	1999-08-24, 10:15:43	15936.0	0.244 ^{+0.0014} _{-0.0015}	0.190 ± 0.010	2.20 ± 0.03	(1.0 ^{+0.0} _{-0.3}) × 10 ³	0.45 ^{+0.04} _{-0.01}	(0.51 ± 0.07) × 10 ⁻³	71.19	32
40097-04-04-01	1999-08-24, 08:39:43	3200.0	0.248 ^{+0.004} _{-0.007}	0.22 ^{+0.02} _{-0.03}	2.24 ^{+0.05} _{-0.07}	-	-	(0.38 ^{+0.17} _{-0.16}) × 10 ⁻³	36.65	29
40098-01-01-00	1999-05-10, 14:37:35	1376.0	0.376 ^{+0.006} _{-0.007}	0.124 ± 0.008	1.76 ± 0.03	-	-	(0.5 ± 0.2) × 10 ⁻³	24.86	30
40098-01-02-00	1999-05-15, 14:32:45	1408.0	0.411 ^{+0.007} _{-0.006}	0.125 ± 0.012	1.73 ^{+0.04} _{-0.05}	-	-	(0.8 ± 0.3) × 10 ⁻³	28.29	32
40098-01-03-00	1999-05-23, 16:02:20	1504.0	0.399 ^{+0.006} _{-0.006}	0.168 ± 0.010	1.88 ± 0.03	-	-	(0.6 ± 0.2) × 10 ⁻³	29.11	30
40098-01-04-00	1999-05-31, 14:15:17	1520.0	0.409 ^{+0.006} _{-0.006}	0.146 ± 0.008	1.80 ± 0.03	-	-	(0.6 ± 0.2) × 10 ⁻³	25.59	32
40098-01-05-00	1999-06-07, 09:18:07	1632.0	0.384 ^{+0.006} _{-0.005}	0.20 ^{+0.03} _{-0.07}	1.98 ^{+0.06} _{-0.18}	-	-	(0.5 ± 0.2) × 10 ⁻³	27.76	31
40098-01-06-00	1999-06-14, 05:57:35	1216.0	0.375 ^{+0.006} _{-0.006}	0.19 ^{+0.02} _{-0.02}	1.98 ^{+0.06} _{-0.10}	-	-	(0.6 ± 0.3) × 10 ⁻³	21.53	30
40098-01-07-00	1999-06-22, 21:53:38	1568.0	0.356 ^{+0.006} _{-0.005}	0.14 ^{+0.04} _{-0.05}	1.86 ^{+0.11} _{-0.19}	-	-	(0.9 ^{+0.3} _{-0.2}) × 10 ⁻³	20.23	30
40098-01-08-00	1999-06-26, 23:25:43	1424.0	0.336 ± 0.006	0.12 ^{+0.04} _{-0.05}	1.8 ^{+0.1} _{-0.2}	-	-	(0.7 ± 0.3) × 10 ⁻³	26.71	28
40098-01-09-00	1999-07-05, 16:47:33	1456.0	0.325 ± 0.006	0.16 ^{+0.02} _{-0.02}	1.95 ^{+0.06} _{-0.06}	-	-	(0.5 ± 0.3) × 10 ⁻³	25.19	28
40098-01-10-00	1999-07-11, 15:01:29	1488.0	0.310 ± 0.006	0.114 ^{+0.014} _{-0.013}	1.82 ^{+0.06} _{-0.06}	-	-	(0.4 ± 0.2) × 10 ⁻³	20.55	28
40098-01-11-00	1999-07-18, 08:26:03	1536.0	0.288 ^{+0.006} _{-0.005}	0.098 ^{+0.008} _{-0.007}	1.78 ± 0.04	-	-	(0.6 ± 0.2) × 10 ⁻³	24.66	29
40098-01-12-00	1999-07-26, 00:16:04	1168.0	0.318 ^{+0.007} _{-0.008}	0.11 ^{+0.01} _{-0.03}	1.79 ^{+0.05} _{-0.05}	-	-	(0.5 ± 0.3) × 10 ⁻³	31.41	28
40098-01-13-00	1999-08-02, 12:55:26	1472.0	0.320 ^{+0.006} _{-0.005}	0.21 ^{+0.03} _{-0.05}	2.09 ^{+0.08} _{-0.11}	-	-	(0.4 ± 0.3) × 10 ⁻³	36.23	28
40098-01-14-00	1999-08-09, 11:09:18	1680.0	0.309 ^{+0.006} _{-0.005}	0.22 ^{+0.00} _{-0.05}	2.13 ^{+0.06} _{-0.12}	-	-	(0.7 ^{+0.3} _{-0.2}) × 10 ⁻³	24.95	27
40098-01-15-00	1999-08-14, 02:31:27	1472.0	0.279 ^{+0.007} _{-0.006}	0.22 ± 0.04	2.21 ^{+0.08} _{-0.09}	(1.0 ^{+0.0} _{-0.3}) × 10 ³	0.45 ^{+0.18} _{-0.03}	(0.4 ± 0.2) × 10 ⁻³	14.42	25
40098-01-16-00	1999-08-23, 02:15:27	1600.0	0.278 ± 0.005	0.20 ^{+0.02} _{-0.08}	2.1 ^{+0.0} _{-0.2}	-	-	(0.3 ± 0.2) × 10 ⁻³	27.52	28
40098-01-17-00	1999-08-30, 13:45:18	1600.0	0.207 ^{+0.006} _{-0.005}	0.19 ^{+0.04} _{-0.06}	2.30 ^{+0.09} _{-0.15}	(1.0 ^{+0.0} _{-0.3}) × 10 ³	0.5 ^{+0.2} _{-0.0}	(0.5 ± 0.2) × 10 ⁻³	18.27	22
40098-01-18-00	1999-09-06, 03:27:02	2112.0	0.242 ^{+0.005} _{-0.004}	0.20 ^{+0.03} _{-0.06}	2.21 ^{+0.06} _{-0.05}	-	-	(0.5 ± 0.2) × 10 ⁻³	21.81	26
40098-01-19-00	1999-09-12, 05:21:18	1616.0	0.262 ± 0.005	0.14 ^{+0.06} _{-0.05}	2.01 ^{+0.05} _{-0.16}	-	-	(0.5 ± 0.2) × 10 ⁻³	13.10	27
40098-01-20-00	1999-09-20, 00:21:19	1552.0	0.188 ^{+0.006} _{-0.005}	0.15 ^{+0.04} _{-0.03}	2.24 ^{+0.10} _{-0.12}	(1.0 ^{+0.0} _{-0.8}) × 10 ³	0.46 ^{+0.13} _{-0.03}	(0.5 ± 0.2) × 10 ⁻³	17.96	21
40098-01-21-00	1999-09-26, 06:32:18	1744.0	0.246 ± 0.005	0.16 ^{+0.02} _{-0.08}	2.1 ^{+0.1} _{-0.3}	-	-	(0.40 ± 0.20) × 10 ⁻³	26.28	26
40098-01-22-00	1999-10-04, 17:35:18	1664.0	0.255 ± 0.005	0.09 ± 0.04	1.8 ± 0.2	-	-	(0.3 ± 0.2) × 10 ⁻³	30.95	29
40098-01-23-00	1999-10-12, 10:55:17	1632.0	0.263 ± 0.005	0.143 ^{+0.011} _{-0.010}	2.00 ± 0.04	-	-	(0.5 ± 0.2) × 10 ⁻³	16.27	27
40098-01-24-00	1999-10-18, 10:40:17	1520.0	0.255 ^{+0.006} _{-0.005}	0.06 ^{+0.04} _{-0.02}	1.6 ± 0.2	-	-	(0.7 ± 0.2) × 10 ⁻³	17.85	27

ObsID	t _{start}	Exposure [s]	Flux [keV/s/cm ²]	Powerlaw norm	Powerlaw Γ	Disk norm	Disk Temperature [keV]	Gauss area photons/s/cm ²	χ^2	Degrees of freedom
40098-01-25-00	1999-10-24, 02:01:36	1152.0	0.285 ^{+0.007} _{-0.006}	0.138 ^{+0.012} _{-0.011}	1.94 ± 0.05	-	-	(0.4 ± 0.3) × 10 ⁻³	24.10	26
40098-01-26-00	1999-11-02, 00:34:20	1584.0	0.240 ^{+0.005} _{-0.004}	0.20 ± 0.03	2.22 ± 0.08	-	-	(0.7 ± 0.2) × 10 ⁻³	52.06	25
40098-01-27-00	1999-11-08, 21:06:19	1648.0	0.269 ± 0.005	0.19 ^{+0.03} _{-0.03}	2.13 ^{+0.03} _{-0.03}	-	-	(0.6 ± 0.2) × 10 ⁻³	34.64	27
40098-01-28-00	1999-11-15, 09:27:44	1920.0	0.273 ± 0.005	0.10 ^{+0.01} _{-0.01}	1.8 ± 0.1	-	-	(0.5 ± 0.2) × 10 ⁻³	23.52	29
40098-01-29-00	2000-01-21, 19:22:23	1648.0	0.346 ^{+0.006} _{-0.005}	0.06 ± 0.02	1.50 ^{+0.12} _{-0.15}	-	-	(0.7 ^{+0.3} _{-0.2}) × 10 ⁻³	20.62	31
40098-01-30-00	2000-01-27, 08:13:41	1456.0	0.328 ± 0.006	0.07 ^{+0.01} _{-0.02}	1.58 ^{+0.05} _{-0.15}	-	-	(0.5 ± 0.2) × 10 ⁻³	20.47	31
40098-01-31-00	2000-02-02, 22:13:19	1648.0	0.340 ^{+0.006} _{-0.005}	0.081 ± 0.005	1.61 ± 0.03	-	-	(0.5 ± 0.2) × 10 ⁻³	34.27	31
40098-01-32-00	2000-02-09, 07:35:15	1328.0	0.394 ^{+0.007} _{-0.006}	0.098 ± 0.006	1.63 ± 0.03	-	-	(0.4 ± 0.2) × 10 ⁻³	26.25	31
40098-01-33-00	2000-02-15, 23:11:16	1488.0	0.402 ^{+0.007} _{-0.007}	0.093 ^{+0.006} _{-0.005}	1.60 ± 0.03	-	-	(0.5 ± 0.2) × 10 ⁻³	31.72	32
40098-01-34-00	2000-02-21, 21:16:16	1488.0	0.417 ^{+0.006} _{-0.006}	0.08 ^{+0.005} _{-0.02}	1.52 ± 0.13	-	-	(0.7 ± 0.3) × 10 ⁻³	29.07	33
40098-01-35-00	2000-02-28, 01:48:48	1408.0	0.449 ^{+0.007} _{-0.006}	0.105 ± 0.006	1.60 ± 0.03	-	-	(0.7 ^{+0.3} _{-0.3}) × 10 ⁻³	22.01	32
40098-01-36-00	2000-10-27, 09:52:32	2176.0	0.414 ^{+0.006} _{-0.005}	0.119 ^{+0.006} _{-0.019}	1.70 ^{+0.03} _{-0.07}	-	-	(0.5 ± 0.2) × 10 ⁻³	39.55	33
40098-01-37-00	2000-03-07, 18:51:16	1520.0	0.458 ^{+0.007} _{-0.007}	0.12 ^{+0.00} _{-0.02}	1.65 ^{+0.03} _{-0.08}	-	-	(0.7 ± 0.2) × 10 ⁻³	37.97	33
40098-01-38-00	2000-03-14, 21:45:16	1632.0	0.508 ^{+0.007} _{-0.007}	0.10 ± 0.02	1.55 ^{+0.08} _{-0.10}	-	-	(0.6 ± 0.3) × 10 ⁻³	38.83	35
40098-01-39-00	2000-03-21, 12:52:32	1744.0	0.514 ^{+0.006} _{-0.006}	0.11 ± 0.01	1.58 ^{+0.05} _{-0.10}	-	-	(0.6 ± 0.3) × 10 ⁻³	29.85	35
40098-01-40-00	2000-03-28, 12:27:11	1776.0	0.473 ± 0.006	0.09 ^{+0.03} _{-0.03}	1.50 ^{+0.11} _{-0.11}	-	-	(0.6 ± 0.2) × 10 ⁻³	33.39	35
40098-01-41-00	2000-04-03, 18:57:26	1456.0	0.527 ^{+0.007} _{-0.006}	0.12 ^{+0.01} _{-0.01}	1.59 ^{+0.04} _{-0.11}	-	-	(0.6 ± 0.3) × 10 ⁻³	20.68	34
40098-01-42-00	2000-04-12, 18:21:17	1488.0	0.534 ^{+0.007} _{-0.009}	0.15 ± 0.01	1.67 ^{+0.04} _{-0.12}	-	-	(0.5 ± 0.3) × 10 ⁻³	23.50	34
40098-01-43-00	2000-04-17, 18:01:17	1552.0	0.539 ^{+0.006} _{-0.006}	0.12 ^{+0.04} _{-0.04}	1.61 ± 0.11	-	-	(0.7 ± 0.3) × 10 ⁻³	33.16	35
40098-01-44-00	2000-04-26, 07:55:18	1600.0	0.534 ^{+0.007} _{-0.007}	0.14 ± 0.02	1.65 ^{+0.06} _{-0.11}	-	-	(0.7 ± 0.3) × 10 ⁻³	19.56	35
40098-01-45-00	1999-11-22, 05:47:47	2000.0	0.271 ± 0.005	0.10 ^{+0.02} _{-0.02}	1.8 ± 0.1	-	-	(0.5 ± 0.2) × 10 ⁻³	25.95	29
40098-01-46-00	1999-11-12, 00:14:39	1504.0	0.269 ^{+0.006} _{-0.006}	0.116 ^{+0.016} _{-0.019}	1.90 ^{+0.06} _{-0.08}	-	-	(0.8 ± 0.2) × 10 ⁻³	25.85	27
40098-01-47-00	1999-11-05, 14:54:29	1328.0	0.280 ± 0.006	0.14 ^{+0.04} _{-0.07}	2.0 ± 0.1	-	-	(0.7 ± 0.2) × 10 ⁻³	23.85	26
40098-01-48-00	1999-10-29, 00:29:26	1472.0	0.287 ^{+0.006} _{-0.005}	0.17 ^{+0.02} _{-0.06}	2.05 ^{+0.06} _{-0.17}	-	-	(0.5 ^{+0.3} _{-0.2}) × 10 ⁻³	24.69	27
40098-01-49-00	1999-10-22, 13:48:52	1408.0	0.275 ^{+0.006} _{-0.006}	0.08 ^{+0.04} _{-0.03}	1.7 ± 0.2	-	-	(0.5 ± 0.2) × 10 ⁻³	27.32	28
40098-01-50-00	1999-10-15, 00:56:02	1488.0	0.266 ^{+0.006} _{-0.005}	0.14 ^{+0.02} _{-0.03}	2.0 ± 0.1	-	-	(0.5 ^{+0.3} _{-0.2}) × 10 ⁻³	17.33	27
40098-01-51-00	1999-10-08, 04:11:22	1136.0	0.257 ^{+0.007} _{-0.006}	0.09 ± 0.04	1.8 ± 0.2	-	-	(2 ⁺³ ₋₂) × 10 ⁻⁴	13.63	26
40098-01-52-00	1999-10-02, 01:18:39	1424.0	0.258 ^{+0.006} _{-0.005}	0.12 ^{+0.03} _{-0.06}	1.9 ± 0.1	-	-	(0.5 ^{+0.3} _{-0.2}) × 10 ⁻³	12.72	27
50106-03-01-00	2000-10-04, 05:29:51	13264.0	0.411 ± 0.002	0.141 ± 0.003	1.781 ± 0.011	-	-	(0.65 ± 0.08) × 10 ⁻³	49.86	35
50107-01-01-00	2000-05-02, 05:26:07	1504.0	0.484 ^{+0.007} _{-0.009}	0.154 ± 0.008	1.75 ± 0.03	-	-	(0.6 ± 0.2) × 10 ⁻³	26.12	33
50107-01-02-00	2000-05-09, 16:33:33	1568.0	0.507 ^{+0.007} _{-0.007}	0.14 ^{+0.01} _{-0.04}	1.66 ^{+0.04} _{-0.12}	-	-	(0.5 ± 0.3) × 10 ⁻³	23.56	35
50107-01-03-00	2000-05-16, 15:58:50	1392.0	0.403 ^{+0.007} _{-0.006}	0.07 ± 0.02	1.51 ^{+0.12} _{-0.13}	-	-	(0.8 ± 0.3) × 10 ⁻³	35.62	33
50107-01-04-00	2000-05-23, 18:38:25	1232.0	0.444 ^{+0.007} _{-0.006}	0.10 ^{+0.02} _{-0.03}	1.61 ^{+0.08} _{-0.14}	-	-	(0.5 ± 0.3) × 10 ⁻³	29.86	33
50107-01-05-00	2000-05-29, 16:12:37	1312.0	0.510 ^{+0.006} _{-0.007}	0.12 ^{+0.03} _{-0.03}	1.62 ^{+0.16} _{-0.12}	-	-	(0.4 ± 0.3) × 10 ⁻³	22.34	34
50107-01-06-00	2000-06-07, 16:03:27	1280.0	0.430 ^{+0.007} _{-0.007}	0.10 ^{+0.02} _{-0.03}	1.58 ^{+0.07} _{-0.13}	-	-	(0.5 ± 0.3) × 10 ⁻³	41.49	33
50107-01-07-00	2000-06-12, 10:19:27	1360.0	0.441 ± 0.007	0.100 ± 0.006	1.59 ± 0.03	-	-	(0.6 ± 0.2) × 10 ⁻³	29.46	33
50107-01-08-00	2000-06-20, 19:23:43	1424.0	0.480 ^{+0.007} _{-0.006}	0.107 ± 0.006	1.58 ± 0.03	-	-	(0.4 ± 0.3) × 10 ⁻³	31.35	33
50107-01-09-00	2000-06-27, 14:33:01	1536.0	0.435 ^{+0.006} _{-0.006}	0.08 ^{+0.03} _{-0.02}	1.50 ± 0.12	-	-	(0.8 ± 0.3) × 10 ⁻³	27.79	33
50107-01-10-00	2000-07-04, 14:01:55	1280.0	0.511 ± 0.006	0.10 ± 0.03	1.54 ^{+0.11} _{-0.12}	-	-	(0.8 ± 0.3) × 10 ⁻³	29.60	34
50107-01-11-00	2000-07-10, 21:32:31	1184.0	0.550 ^{+0.009} _{-0.007}	0.146 ± 0.008	1.66 ± 0.03	-	-	(1.0 ± 0.3) × 10 ⁻³	36.38	33
50107-01-12-00	2000-07-19, 14:21:53	1312.0	0.551 ^{+0.008} _{-0.007}	0.143 ± 0.008	1.65 ± 0.03	-	-	(0.7 ± 0.3) × 10 ⁻³	25.76	34

ObsID	t_{start}	Exposure [s]	Flux [keV/s/cm ²]	Powerlaw norm	Powerlaw Γ	Disk norm	Disk Temperature [keV]	Gauss area photons/s/cm ²	χ^2	Degrees of freedom
50107-01-13-00	2000-07-25, 01:09:35	928.0	$0.544^{+0.010}_{-0.008}$	$0.12^{+0.02}_{-0.04}$	$1.58^{+0.07}_{-0.14}$	-	-	$(1.1 \pm 0.4) \times 10^{-3}$	31.24	32
50107-01-14-00	2000-08-01, 08:24:25	1680.0	$0.478^{+0.007}_{-0.009}$	$0.11^{+0.01}_{-0.03}$	$1.61^{+0.05}_{-0.12}$	-	-	$(0.6 \pm 0.3) \times 10^{-3}$	24.87	34
50107-01-15-00	2000-08-08, 12:40:19	1680.0	$0.521^{+0.007}_{-0.006}$	0.121 ± 0.006	1.60 ± 0.03	-	-	$(0.7 \pm 0.3) \times 10^{-3}$	16.62	34
50107-01-16-00	2000-08-15, 05:21:03	1760.0	$0.548^{+0.006}_{-0.007}$	0.139 ± 0.006	1.64 ± 0.02	-	-	$(0.7^{+0.2}_{-0.3}) \times 10^{-3}$	24.78	35
50107-01-17-00	2000-08-23, 09:50:21	1424.0	$0.576^{+0.008}_{-0.007}$	$0.19^{+0.02}_{-0.05}$	$1.76^{+0.04}_{-0.12}$	-	-	$(0.5 \pm 0.3) \times 10^{-3}$	29.91	34
50107-01-18-00	2000-08-29, 08:52:33	1392.0	$0.578^{+0.008}_{-0.007}$	$0.151^{+0.008}_{-0.007}$	1.65 ± 0.03	-	-	$(0.7 \pm 0.3) \times 10^{-3}$	24.55	34
60086-01-01-00	2001-03-02, 22:45:35	1632.0	$0.091^{+0.003}_{-0.005}$	$0.06^{+0.06}_{-0.03}$	$2.3^{+0.3}_{-0.4}$	$(1.0^{+0.0}_{-0.4}) \times 10^3$	$0.53^{+0.05}_{-0.01}$	$(0.40 \pm 0.17) \times 10^{-3}$	11.20	14
60086-01-02-00	2001-03-06, 23:52:15	1680.0	0.093 ± 0.004	$0.04^{+0.04}_{-0.02}$	$2.1^{+0.3}_{-0.4}$	$(1.0^{+0.0}_{-0.4}) \times 10^3$	$0.53^{+0.04}_{-0.01}$	$(0.58 \pm 0.17) \times 10^{-3}$	10.78	14
60086-01-03-00	2001-03-10, 04:13:15	1488.0	0.087 ± 0.005	$0.04^{+0.04}_{-0.03}$	$2.2^{+0.3}_{-0.6}$	$(1.0^{+0.0}_{-0.6}) \times 10^3$	$0.52^{+0.07}_{-0.01}$	$(0.34^{+0.19}_{-0.18}) \times 10^{-3}$	8.48	14
60086-01-04-00	2001-03-13, 21:05:51	1456.0	$0.080^{+0.003}_{-0.006}$	$0.013^{+0.016}_{-0.007}$	1.7 ± 0.4	$(1.0^{+0.0}_{-0.3}) \times 10^3$	$0.52^{+0.03}_{-0.01}$	$(0.44 \pm 0.18) \times 10^{-3}$	20.26	14
60086-01-05-00	2001-03-16, 19:22:15	1472.0	$0.075^{+0.005}_{-0.003}$	$0.016^{+0.020}_{-0.009}$	1.8 ± 0.4	$(1.0^{+0.0}_{-0.4}) \times 10^3$	$0.52^{+0.03}_{-0.01}$	$(0.56 \pm 0.18) \times 10^{-3}$	10.37	13
60086-01-06-00	2001-03-18, 15:39:59	1584.0	0.070 ± 0.004	$0.02^{+0.02}_{-0.01}$	1.9 ± 0.5	$(1.0^{+0.0}_{-0.3}) \times 10^3$	$0.52^{+0.03}_{-0.01}$	$(0.49 \pm 0.17) \times 10^{-3}$	12.92	12
60086-01-07-00	2001-03-25, 18:08:47	1536.0	$0.063^{+0.005}_{-0.004}$	$0.02^{+0.02}_{-0.01}$	2.0 ± 0.4	$(1.0^{+0.0}_{-0.4}) \times 10^3$	$0.49^{+0.03}_{-0.01}$	$(0.37 \pm 0.17) \times 10^{-3}$	19.96	13
60086-01-08-00	2001-03-28, 16:08:15	1216.0	≤ 19	$0.03^{+0.05}_{-0.02}$	$2.2^{+0.6}_{-0.8}$	$(1.0^{+0.0}_{-0.8}) \times 10^3$	$0.48^{+0.13}_{-0.02}$	$(0.34^{+0.19}_{-0.18}) \times 10^{-3}$	4.51	10
60086-01-09-00	2001-04-02, 11:59:47	1376.0	$0.051^{+0.005}_{-0.003}$	$0.02^{+0.03}_{-0.01}$	$2.0^{+0.4}_{-0.5}$	$(1.0^{+0.0}_{-0.7}) \times 10^3$	$0.47^{+0.09}_{-0.02}$	$(0.38 \pm 0.17) \times 10^{-3}$	8.07	11
60086-01-10-00	2001-04-04, 02:37:51	1408.0	≤ 19	$0.03^{+0.03}_{-0.02}$	$2.1^{+0.4}_{-0.8}$	$(1.0^{+0.0}_{-0.9}) \times 10^3$	$0.4^{+0.2}_{-0.0}$	$(0.36^{+0.19}_{-0.17}) \times 10^{-3}$	5.58	12
60086-01-11-00	2001-04-08, 05:19:32	1168.0	≤ 19	$0.01^{+0.02}_{-0.01}$	$1.6^{+0.7}_{-1.1}$	$(1.0^{+0.0}_{-0.8}) \times 10^3$	$0.47^{+0.14}_{-0.02}$	$(0.5 \pm 0.2) \times 10^{-3}$	4.21	10
60086-01-12-00	2001-04-12, 01:24:38	1456.0	$0.054^{+0.009}_{-0.008}$	$0.002^{+0.014}_{-0.002}$	$1.0^{+0.9}_{-1.0}$	$(0.1^{+0.9}_{-0.1}) \times 10^3$	$0.63^{+0.17}_{-0.19}$	$(0.46^{+0.18}_{-0.20}) \times 10^{-3}$	6.97	13
60086-01-13-00	2001-04-15, 04:14:50	1456.0	0.049 ± 0.005	$0.008^{+0.019}_{-0.006}$	1.6 ± 0.6	$(0.3^{+0.7}_{-0.2}) \times 10^3$	$0.53^{+0.17}_{-0.10}$	$(0.45^{+0.17}_{-0.20}) \times 10^{-3}$	9.17	13
60086-01-14-00	2001-04-18, 03:48:03	1440.0	$0.037^{+0.004}_{-0.003}$	$0.03^{+0.03}_{-0.02}$	$2.2^{+0.4}_{-0.7}$	-	-	$(0.37^{+0.18}_{-0.16}) \times 10^{-3}$	17.97	12
60086-01-15-00	2001-04-20, 16:17:17	1680.0	0.039 ± 0.003	$0.016^{+0.014}_{-0.018}$	1.9 ± 0.4	-	-	$(0.53 \pm 0.15) \times 10^{-3}$	30.48	13
60086-01-16-00	2001-04-24, 18:59:17	1600.0	$0.042^{+0.004}_{-0.003}$	$0.019^{+0.018}_{-0.010}$	$1.9^{+0.3}_{-0.4}$	-	-	$(0.40 \pm 0.16) \times 10^{-3}$	19.38	14
60086-01-17-00	2001-04-28, 15:05:04	1584.0	$0.043^{+0.004}_{-0.003}$	$0.03^{+0.04}_{-0.03}$	$2.2^{+1.0}_{-1.0}$	-	-	$(2.9 \pm 1.7) \times 10^{-4}$	7.70	13
60086-01-18-00	2001-05-03, 01:22:07	1424.0	0.039 ± 0.004	$0.03^{+0.02}_{-0.03}$	2^{+0}_{-2}	-	-	$(0.46^{+0.17}_{-0.16}) \times 10^{-3}$	14.46	12
60086-01-19-00	2001-05-06, 04:12:19	1472.0	$0.042^{+0.004}_{-0.003}$	$0.03^{+0.03}_{-0.02}$	$2.1^{+0.3}_{-0.6}$	-	-	$(3.0^{+1.8}_{-1.6}) \times 10^{-4}$	21.31	13
60086-01-20-00	2001-05-09, 22:46:23	1408.0	0.039 ± 0.004	0.03 ± 0.02	$2.1^{+0.4}_{-0.7}$	-	-	$(2.3^{+1.7}_{-1.6}) \times 10^{-4}$	9.54	13
60086-01-21-00	2001-05-12, 16:26:41	1568.0	$0.043^{+0.004}_{-0.003}$	$0.031^{+0.016}_{-0.015}$	$2.2^{+0.2}_{-0.3}$	-	-	$(0.48^{+0.16}_{-0.15}) \times 10^{-3}$	12.08	14
60086-01-22-00	2001-05-14, 14:28:43	1280.0	0.040 ± 0.004	0.03 ± 0.03	2^{+0}_{-2}	-	-	$(3.0^{+1.8}_{-1.7}) \times 10^{-4}$	13.81	13
60086-01-24-00	2001-05-24, 14:42:25	1472.0	0.067 ± 0.004	$0.075^{+0.018}_{-0.011}$	2.37 ± 0.13	-	-	$(0.38 \pm 0.16) \times 10^{-3}$	19.24	16
60086-01-25-00	2001-05-26, 13:01:20	912.0	0.073 ± 0.005	$0.05^{+0.04}_{-0.05}$	$2.2^{+0.3}_{-0.8}$	-	-	$(0.4 \pm 0.2) \times 10^{-3}$	21.15	14
60086-01-26-00	2001-05-29, 17:17:01	1168.0	0.068 ± 0.004	$0.09^{+0.04}_{-0.06}$	$2.5^{+0.2}_{-0.3}$	-	-	$(0.40 \pm 0.19) \times 10^{-3}$	10.58	14
60086-01-27-00	2001-06-02, 14:58:51	1392.0	0.051 ± 0.003	0.06 ± 0.04	$2.4^{+0.5}_{-0.5}$	-	-	$(0.45 \pm 0.17) \times 10^{-3}$	14.83	14
60086-01-28-00	2001-06-05, 14:37:51	1296.0	0.045 ± 0.004	$0.03^{+0.03}_{-0.02}$	$2.2^{+0.4}_{-0.6}$	-	-	$(0.42^{+0.19}_{-0.17}) \times 10^{-3}$	20.26	13
60086-01-29-00	2001-06-08, 01:37:40	736.0	0.044 ± 0.005	$0.02^{+0.03}_{-0.01}$	1.9 ± 0.5	-	-	$(0.5 \pm 0.2) \times 10^{-3}$	20.06	11
60086-01-30-00	2001-06-12, 10:22:28	1440.0	$0.049^{+0.006}_{-0.005}$	$0.012^{+0.014}_{-0.007}$	1.8 ± 0.4	$(1.0^{+0.0}_{-0.7}) \times 10^3$	$0.45^{+0.08}_{-0.02}$	$(0.50 \pm 0.17) \times 10^{-3}$	14.50	12
60086-01-31-00	2001-06-16, 06:38:55	1184.0	0.043 ± 0.004	$0.02^{+0.03}_{-0.03}$	2.1 ± 0.4	-	-	$(3.0 \pm 1.8) \times 10^{-4}$	18.87	13
60086-01-32-00	2001-06-18, 14:21:35	1440.0	$0.044^{+0.004}_{-0.003}$	$0.04^{+0.03}_{-0.02}$	$2.2^{+0.3}_{-0.5}$	-	-	$(0.47 \pm 0.17) \times 10^{-3}$	20.55	13
60086-01-33-00	2001-06-24, 16:44:17	576.0	$0.061^{+0.007}_{-0.006}$	$0.04^{+0.03}_{-0.04}$	$2.2^{+0.3}_{-1.5}$	-	-	$(0.4 \pm 0.3) \times 10^{-3}$	9.79	11
60086-01-34-00	2001-06-29, 00:20:47	336.0	$0.056^{+0.010}_{-0.008}$	$0.07^{+0.11}_{-0.07}$	2^{+1}_{-2}	-	-	$(0.6^{+0.5}_{-0.4}) \times 10^{-3}$	6.54	8
60086-01-36-00	2001-07-05, 11:46:45	1248.0	0.064 ± 0.005	0.04 ± 0.02	$2.1^{+0.2}_{-0.2}$	-	-	$(0.5 \pm 0.2) \times 10^{-3}$	13.82	14
60086-01-37-00	2001-07-09, 14:26:46	1296.0	≤ 19	0.06 ± 0.03	$2.1^{+0.2}_{-0.4}$	$(1.0^{+0.0}_{-1.0}) \times 10^3$	$0.4^{+0.3}_{-0.0}$	$(0.5 \pm 0.2) \times 10^{-3}$	9.01	16

ObsID	t_{start}	Exposure [s]	Flux [keV/s/cm ²]	Powerlaw norm	Powerlaw Γ	Disk norm	Disk Temperature [keV]	Gauss area photons/s/cm ²	χ^2	Degrees of freedom
60086-01-38-00	2001-07-12, 10:53:21	1008.0	$0.156^{+0.006}_{-0.005}$	$0.10^{+0.03}_{-0.04}$	$2.1^{+0.1}_{-0.2}$	-	-	$(0.7 \pm 0.3) \times 10^{-3}$	13.04	20
60086-01-39-00	2001-07-15, 19:51:28	1408.0	0.180 ± 0.005	$0.10^{+0.01}_{-0.04}$	$2.0^{+0.1}_{-0.2}$	-	-	$(0.6 \pm 0.2) \times 10^{-3}$	22.41	24
60086-01-40-00	2001-07-19, 05:08:58	160.0	$0.151^{+0.014}_{-0.013}$	$0.02^{+0.18}_{-0.02}$	$1.4^{+1.1}_{-1.3}$	-	-	$(0.5^{+0.7}_{-0.5}) \times 10^{-3}$	6.12	11
60086-01-41-00	2001-07-21, 09:33:51	832.0	$0.117^{+0.011}_{-0.008}$	$0.04^{+0.04}_{-0.03}$	$1.9^{+0.3}_{-0.6}$	-	-	$(0.7 \pm 0.3) \times 10^{-3}$	15.09	15
60086-01-42-00	2001-07-24, 09:03:38	944.0	$0.159^{+0.006}_{-0.007}$	$0.15^{+0.05}_{-0.07}$	$2.3^{+0.1}_{-0.2}$	-	-	$(0.6 \pm 0.3) \times 10^{-3}$	14.19	19
60086-01-43-00	2001-07-28, 09:56:31	1344.0	$0.213^{+0.006}_{-0.005}$	0.07 ± 0.04	$1.8^{+0.3}_{-0.4}$	-	-	$(0.7 \pm 0.3) \times 10^{-3}$	23.61	25
60086-01-44-00	2001-07-31, 11:08:31	1152.0	0.170 ± 0.005	$0.15^{+0.06}_{-0.09}$	$2.2^{+0.2}_{-0.4}$	-	-	$(0.6 \pm 0.3) \times 10^{-3}$	14.26	20
60086-01-45-00	2001-08-04, 13:12:56	1504.0	$0.065^{+0.006}_{-0.005}$	$0.03^{+0.04}_{-0.02}$	$2.0^{+0.5}_{-0.6}$	-	-	$(0.6 \pm 0.2) \times 10^{-3}$	10.57	13
60086-01-46-00	2001-08-08, 08:10:18	1536.0	$0.064^{+0.004}_{-0.005}$	$0.06^{+0.06}_{-0.05}$	$2.4^{+0.4}_{-1.0}$	-	-	$(0.3 \pm 0.2) \times 10^{-3}$	11.00	12
60086-01-47-00	2001-08-10, 07:52:18	1328.0	$0.068^{+0.004}_{-0.005}$	$0.03^{+0.03}_{-0.02}$	$2.0^{+0.4}_{-0.6}$	-	-	$(0.5 \pm 0.2) \times 10^{-3}$	7.50	13
60086-01-48-00	2001-08-14, 05:30:40	1472.0	≤ 19	$0.05^{+0.06}_{-0.03}$	$2.3^{+0.4}_{-0.5}$	-	-	$(0.51 \pm 0.18) \times 10^{-3}$	8.20	11
60086-01-49-00	2001-08-18, 11:36:17	1408.0	$0.066^{+0.004}_{-0.006}$	$0.012^{+0.014}_{-0.009}$	$1.7^{+0.4}_{-0.6}$	-	-	$(0.6 \pm 0.2) \times 10^{-3}$	7.86	14
60086-01-50-00	2001-08-22, 10:55:17	1616.0	0.058 ± 0.005	$0.03^{+0.03}_{-0.02}$	$2.1^{+0.3}_{-0.6}$	-	-	$(0.35^{+0.19}_{-0.18}) \times 10^{-3}$	8.58	13
60086-01-51-00	2001-08-24, 08:32:31	1088.0	$0.058^{+0.001}_{-0.007}$	$0.02^{+0.04}_{-0.02}$	$2.0^{+0.5}_{-0.7}$	-	-	$(0.6 \pm 0.2) \times 10^{-3}$	10.50	11
60086-01-51-01	2001-08-24, 07:29:18	672.0	0.047 ± 0.005	$0.03^{+0.03}_{-0.03}$	$2.1^{+0.3}_{-0.9}$	-	-	$(0.7 \pm 0.3) \times 10^{-3}$	6.15	10
60086-01-52-00	2001-08-29, 04:35:11	2128.0	0.051 ± 0.004	$0.04^{+0.03}_{-0.02}$	$2.2^{+0.3}_{-0.4}$	-	-	$(0.40 \pm 0.15) \times 10^{-3}$	8.19	13
60086-01-53-00	2001-09-01, 06:03:16	1216.0	0.043 ± 0.004	$0.03^{+0.04}_{-0.02}$	$2.2^{+0.4}_{-0.5}$	-	-	$(0.45 \pm 0.19) \times 10^{-3}$	31.79	11
60086-01-54-00	2001-09-04, 15:12:40	1568.0	$0.051^{+0.006}_{-0.005}$	$0.02^{+0.03}_{-0.02}$	$2.0^{+0.4}_{-0.6}$	-	-	$(0.47 \pm 0.17) \times 10^{-3}$	7.78	12
60086-01-55-00	2001-09-09, 14:22:23	1552.0	0.047 ± 0.004	$0.06^{+0.04}_{-0.06}$	$2.4^{+0.3}_{-1.4}$	-	-	$(0.32^{+0.18}_{-0.17}) \times 10^{-3}$	10.80	12
60086-01-56-00	2001-09-11, 14:19:17	816.0	0.043 ± 0.005	$0.03^{+0.05}_{-0.02}$	$2.1^{+0.5}_{-0.7}$	-	-	$(0.5 \pm 0.2) \times 10^{-3}$	14.04	11
60086-01-57-00	2001-09-14, 08:54:17	1424.0	0.047 ± 0.004	0.03 ± 0.02	$2.1^{+0.3}_{-0.4}$	-	-	$(0.35^{+0.19}_{-0.18}) \times 10^{-3}$	18.21	14
60086-01-58-00	2001-09-18, 09:55:16	1200.0	0.036 ± 0.004	$0.04^{+0.05}_{-0.04}$	$2.4^{+0.4}_{-1.1}$	-	-	$(0.5 \pm 0.2) \times 10^{-3}$	15.36	11
60086-01-59-00	2001-09-21, 18:22:23	880.0	$0.041^{+0.006}_{-0.005}$	$0.03^{+0.04}_{-0.02}$	$2.1^{+0.5}_{-0.8}$	-	-	$(0.4 \pm 0.2) \times 10^{-3}$	12.88	10
60086-01-60-00	2001-09-24, 13:23:43	1456.0	0.037 ± 0.004	$0.02^{+0.02}_{-0.01}$	$1.9^{+0.5}_{-0.7}$	-	-	$(0.48 \pm 0.18) \times 10^{-3}$	27.97	12
60086-01-61-00	2001-09-30, 03:04:17	1376.0	0.039 ± 0.004	$0.01^{+0.03}_{-0.03}$	$1.8^{+0.7}_{-1.0}$	-	-	$(0.59^{+0.20}_{-0.19}) \times 10^{-3}$	21.80	12
60086-01-62-00	2001-10-02, 23:13:37	1488.0	0.039 ± 0.004	$0.01^{+0.03}_{-0.01}$	$1.6^{+0.2}_{-1.5}$	-	-	$(0.6 \pm 0.2) \times 10^{-3}$	11.47	13
60086-01-63-00	2001-10-07, 05:10:17	1424.0	0.036 ± 0.004	$0.02^{+0.03}_{-0.01}$	$2.0^{+0.5}_{-0.8}$	-	-	$(0.53^{+0.18}_{-0.17}) \times 10^{-3}$	16.82	11
60086-01-64-00	2001-10-10, 11:07:17	1568.0	0.038 ± 0.004	$0.011^{+0.016}_{-0.011}$	$1.7^{+0.5}_{-1.3}$	-	-	$(0.5 \pm 0.2) \times 10^{-3}$	10.57	13
60086-01-65-00	2001-10-13, 05:47:17	1472.0	0.040 ± 0.004	0.02 ± 0.02	$2.0^{+0.3}_{-1.4}$	-	-	$(0.37^{+0.18}_{-0.17}) \times 10^{-3}$	6.51	13
60086-01-66-00	2001-10-17, 03:27:17	1216.0	0.048 ± 0.005	$0.01^{+0.02}_{-0.01}$	$1.5^{+0.6}_{-1.5}$	-	-	$(0.4 \pm 0.2) \times 10^{-3}$	17.37	13
60086-01-67-00	2001-10-20, 12:35:17	1536.0	0.043 ± 0.004	$0.024^{+0.010}_{-0.007}$	2.0 ± 0.2	-	-	$(2.9 \pm 1.6) \times 10^{-4}$	15.09	13
60086-01-68-00	2001-10-24, 11:52:06	1648.0	0.043 ± 0.004	$0.020^{+0.020}_{-0.015}$	$2.0^{+0.4}_{-0.7}$	-	-	$(0.47^{+0.18}_{-0.16}) \times 10^{-3}$	15.45	13
60086-01-69-00	2001-10-27, 06:32:17	1472.0	0.047 ± 0.004	$0.02^{+0.01}_{-0.02}$	$2.0^{+0.2}_{-1.0}$	-	-	$(0.45 \pm 0.17) \times 10^{-3}$	12.34	14
60086-01-70-00	2001-10-31, 02:12:47	1376.0	0.038 ± 0.004	0.03 ± 0.03	$2.0^{+0.2}_{-0.9}$	-	-	$(0.3 \pm 0.2) \times 10^{-3}$	10.04	12
60086-01-71-00	2001-11-03, 10:00:15	1424.0	$0.044^{+0.005}_{-0.004}$	$0.019^{+0.018}_{-0.014}$	$1.9^{+0.6}_{-0.6}$	-	-	$(0.48 \pm 0.17) \times 10^{-3}$	18.73	12
60086-01-72-00	2001-11-06, 19:10:26	752.0	0.064 ± 0.006	0.04 ± 0.04	$2.1^{+0.3}_{-1.7}$	-	-	$(0.7^{+0.3}_{-0.2}) \times 10^{-3}$	13.28	12
60086-01-73-00	2001-11-10, 02:33:58	1376.0	$0.094^{+0.005}_{-0.004}$	$0.06^{+0.02}_{-0.05}$	$2.1^{+0.1}_{-0.6}$	-	-	$(0.6 \pm 0.2) \times 10^{-3}$	22.66	18
60086-01-74-00	2001-11-14, 14:40:11	1024.0	$0.110^{+0.004}_{-0.005}$	$0.04^{+0.05}_{-0.03}$	$1.9^{+0.6}_{-0.7}$	-	-	$(0.6 \pm 0.2) \times 10^{-3}$	16.73	19
60086-01-75-00	2001-11-16, 23:39:41	1360.0	0.111 ± 0.005	$0.03^{+0.03}_{-0.02}$	$1.6^{+0.7}_{-0.7}$	-	-	$(2 \pm 2) \times 10^{-4}$	22.53	20
60086-01-76-00	2001-11-20, 05:00:06	1344.0	0.109 ± 0.005	0.03 ± 0.02	$1.7^{+0.2}_{-0.5}$	-	-	$(0.5 \pm 0.2) \times 10^{-3}$	21.87	19
60086-01-77-00	2001-11-22, 09:30:23	2176.0	0.108 ± 0.004	0.0400 ± 0.0011	$1.8^{+0.5}_{-0.2}$	-	-	$(0.40 \pm 0.13) \times 10^{-3}$	19.02	22

ObsID	t _{start}	Exposure [s]	Flux [keV/s/cm ²]	Powerlaw norm	Powerlaw Γ	Disk norm	Disk Temperature [keV]	Gauss area photons/s/cm ²	χ^2	Degrees of freedom
60086-01-78-00	2002-01-20, 15:32:23	1392.0	0.343 ± 0.006	0.12 ^{+0.01} _{-0.03}	1.78 ^{+0.04} _{-0.12}	-	-	(0.7 ^{+0.3} _{-0.2}) × 10 ⁻³	33.64	31
60086-01-79-00	2002-01-23, 16:28:15	1472.0	0.358 ^{+0.006} _{-0.005}	0.11 ± 0.03	1.73 ^{+0.12} _{-0.16}	-	-	(0.4 ± 0.2) × 10 ⁻³	33.93	31
60086-01-80-00	2002-01-28, 23:48:17	1536.0	0.346 ^{+0.005} _{-0.005}	0.11 ^{+0.01} _{-0.03}	1.74 ^{+0.03} _{-0.13}	-	-	(0.5 ± 0.2) × 10 ⁻³	28.53	31
60086-01-81-00	2002-01-30, 05:56:17	1536.0	0.350 ^{+0.007} _{-0.005}	0.105 ^{+0.007} _{-0.007}	1.72 ± 0.03	-	-	(0.5 ± 0.2) × 10 ⁻³	29.86	31
60086-01-82-00	2002-02-02, 15:54:56	1600.0	0.365 ^{+0.005} _{-0.006}	0.110 ^{+0.007} _{-0.006}	1.72 ± 0.03	-	-	(0.6 ± 0.2) × 10 ⁻³	12.93	31
60086-01-83-00	2002-02-06, 07:43:29	1104.0	0.376 ^{+0.007} _{-0.006}	0.126 ^{+0.009} _{-0.008}	1.75 ± 0.04	-	-	(0.5 ± 0.3) × 10 ⁻³	23.67	31
60086-01-84-00	2002-02-10, 01:44:32	1472.0	0.409 ± 0.006	0.16 ^{+0.03} _{-0.05}	1.83 ^{+0.04} _{-0.10}	-	-	(0.5 ± 0.3) × 10 ⁻³	36.34	31
60086-01-85-00	2002-02-13, 21:59:31	1360.0	0.417 ^{+0.007} _{-0.006}	0.11 ^{+0.03} _{-0.03}	1.67 ^{+0.16} _{-0.15}	-	-	(0.6 ± 0.3) × 10 ⁻³	32.48	32
60086-01-86-00	2002-02-16, 10:19:27	1040.0	0.414 ^{+0.008} _{-0.007}	0.139 ^{+0.010} _{-0.010}	1.77 ± 0.04	-	-	(0.6 ± 0.3) × 10 ⁻³	22.54	31
60086-01-87-00	2002-02-20, 10:55:02	1040.0	0.411 ^{+0.007} _{-0.007}	0.140 ^{+0.009} _{-0.009}	1.78 ± 0.04	-	-	(0.7 ± 0.3) × 10 ⁻³	22.34	29
60086-01-88-00	2002-02-23, 07:00:31	1776.0	0.429 ^{+0.006} _{-0.005}	0.15 ^{+0.01} _{-0.03}	1.81 ^{+0.04} _{-0.08}	-	-	(0.6 ^{+0.3} _{-0.2}) × 10 ⁻³	27.53	33
60086-01-89-00	2002-02-27, 20:32:16	1408.0	0.443 ^{+0.006} _{-0.005}	0.22 ^{+0.08} _{-0.09}	1.98 ^{+0.13} _{-0.19}	-	-	(1.0 ± 0.3) × 10 ⁻³	24.96	32
60086-01-90-00	2002-05-02, 11:29:19	1872.0	0.315 ± 0.005	0.08 ^{+0.01} _{-0.02}	1.62 ^{+0.07} _{-0.07}	-	-	(0.5 ± 0.2) × 10 ⁻³	30.41	32
70102-01-01-00	2002-03-02, 14:57:17	1408.0	0.438 ^{+0.006} _{-0.005}	0.29 ^{+0.05} _{-0.06}	2.09 ^{+0.07} _{-0.10}	-	-	(0.5 ± 0.3) × 10 ⁻³	36.22	31
70102-01-02-00	2002-03-06, 06:23:16	1328.0	0.436 ^{+0.007} _{-0.006}	0.27 ^{+0.06} _{-0.05}	2.07 ^{+0.05} _{-0.09}	-	-	(0.6 ± 0.3) × 10 ⁻³	38.92	30
70102-01-03-00	2002-03-10, 05:28:31	1392.0	0.293 ^{+0.005} _{-0.006}	0.27 ^{+0.06} _{-0.07}	2.32 ^{+0.09} _{-0.14}	(1.0 ± 0.0) × 10 ³	0.53 ^{+0.10} _{-0.01}	(0.4 ± 0.3) × 10 ⁻³	24.83	24
70102-01-04-00	2002-03-14, 21:55:16	1600.0	0.207 ± 0.005	0.14 ^{+0.05} _{-0.04}	2.25 ^{+0.13} _{-0.15}	(1.0 ± 0.0) × 10 ³	0.55 ^{+0.04} _{-0.01}	(0.5 ± 0.2) × 10 ⁻³	20.88	22
70102-01-05-00	2002-03-16, 13:04:20	1520.0	0.226 ^{+0.006} _{-0.005}	0.18 ± 0.07	2.3 ± 0.2	(0.7 ± 0.3) × 10 ³	0.56 ^{+0.08} _{-0.03}	(0.4 ^{+0.2} _{-0.3}) × 10 ⁻³	20.83	23
70102-01-06-00	2002-03-18, 16:00:08	1408.0	0.225 ^{+0.006} _{-0.005}	0.16 ^{+0.05} _{-0.04}	2.24 ^{+0.12} _{-0.13}	(1.0 ± 0.0) × 10 ³	0.54 ^{+0.04} _{-0.01}	(0.6 ± 0.2) × 10 ⁻³	22.86	23
70102-01-07-00	2002-03-23, 02:25:16	1536.0	0.302 ^{+0.006} _{-0.005}	0.30 ^{+0.09} _{-0.04}	2.32 ^{+0.07} _{-0.08}	(1.0 ± 0.0) × 10 ³	0.48 ^{+0.11} _{-0.02}	(0.4 ± 0.2) × 10 ⁻³	20.47	26
70102-01-08-00	2002-03-26, 14:03:02	1424.0	0.274 ^{+0.006} _{-0.005}	0.24 ± 0.05	2.28 ^{+0.09} _{-0.12}	(1.0 ± 0.0) × 10 ³	0.51 ^{+0.10} _{-0.07}	(0.7 ^{+0.3} _{-0.2}) × 10 ⁻³	15.86	26
70102-01-09-00	2002-03-31, 03:47:27	1232.0	0.111 ^{+0.004} _{-0.006}	0.05 ^{+0.04} _{-0.03}	2.1 ^{+0.3} _{-0.5}	(1.0 ± 0.0) × 10 ³	0.53 ^{+0.08} _{-0.01}	(0.5 ± 0.3) × 10 ⁻³	8.51	15
70102-01-10-00	2002-04-03, 21:43:27	1488.0	0.256 ^{+0.004} _{-0.005}	0.20 ^{+0.04} _{-0.05}	2.22 ^{+0.09} _{-0.14}	(1.0 ± 0.0) × 10 ³	0.50 ^{+0.12} _{-0.02}	(0.6 ^{+0.3} _{-0.2}) × 10 ⁻³	16.58	25
70102-01-11-00	2005-01-20, 18:46:34	1472.0	0.641 ^{+0.008} _{-0.008}	0.18 ^{+0.01} _{-0.01}	1.69 ^{+0.03} _{-0.10}	-	-	(0.5 ± 0.3) × 10 ⁻³	36.76	36
70102-01-12-00	2005-01-24, 01:28:49	1392.0	0.623 ^{+0.008} _{-0.007}	0.169 ^{+0.008} _{-0.007}	1.67 ± 0.02	-	-	(0.4 ± 0.3) × 10 ⁻³	52.09	36
70102-01-13-00	2006-01-22, 13:23:59	1376.0	0.714 ^{+0.008} _{-0.007}	0.19 ^{+0.01} _{-0.02}	1.66 ^{+0.03} _{-0.05}	-	-	(0.8 ± 0.3) × 10 ⁻³	26.27	35
70102-01-14-00	2002-04-18, 04:04:31	816.0	0.339 ^{+0.007} _{-0.007}	0.14 ^{+0.06} _{-0.06}	1.9 ^{+0.2} _{-0.2}	-	-	(0.3 ± 0.3) × 10 ⁻³	23.33	27
70102-01-15-00	2002-04-20, 21:12:17	1360.0	0.336 ^{+0.006} _{-0.005}	0.14 ^{+0.01} _{-0.04}	1.87 ^{+0.05} _{-0.13}	-	-	(0.8 ^{+0.3} _{-0.2}) × 10 ⁻³	28.15	30
70102-01-16-00	2002-04-23, 12:24:18	1328.0	0.327 ± 0.006	0.106 ^{+0.008} _{-0.007}	1.76 ± 0.04	-	-	(0.7 ± 0.2) × 10 ⁻³	27.35	30
70102-01-17-00	2002-04-26, 00:44:18	1472.0	0.308 ^{+0.006} _{-0.005}	0.08 ^{+0.01} _{-0.01}	1.63 ^{+0.07} _{-0.15}	-	-	(0.4 ± 0.2) × 10 ⁻³	24.21	32
70102-01-18-00	2002-04-29, 17:23:20	1600.0	0.302 ^{+0.005} _{-0.005}	0.08 ^{+0.03} _{-0.03}	1.67 ^{+0.15} _{-0.15}	-	-	(0.4 ± 0.2) × 10 ⁻³	22.58	31
70102-01-19-00	2002-05-04, 03:31:25	1648.0	0.318 ^{+0.006} _{-0.005}	0.06 ^{+0.03} _{-0.02}	1.49 ± 0.15	-	-	(0.6 ± 0.2) × 10 ⁻³	17.89	32
70102-01-20-00	2002-05-08, 16:46:32	1504.0	0.327 ^{+0.006} _{-0.007}	0.083 ^{+0.006} _{-0.005}	1.64 ± 0.03	-	-	(0.4 ± 0.2) × 10 ⁻³	20.36	31
70102-01-21-00	2002-05-10, 14:37:35	1264.0	0.333 ^{+0.007} _{-0.007}	0.084 ± 0.006	1.64 ± 0.04	-	-	(0.6 ± 0.2) × 10 ⁻³	27.09	30
70102-01-22-00	2005-01-28, 17:13:53	1312.0	0.604 ^{+0.008} _{-0.007}	0.16 ^{+0.03} _{-0.04}	1.66 ^{+0.08} _{-0.13}	-	-	(0.8 ± 0.3) × 10 ⁻³	25.48	35
70102-01-23-00	2002-05-17, 17:42:53	1536.0	0.366 ± 0.006	0.07 ^{+0.03} _{-0.03}	1.54 ^{+0.13} _{-0.13}	-	-	(0.6 ± 0.3) × 10 ⁻³	28.61	33
70102-01-24-00	2002-05-22, 22:48:23	1344.0	0.410 ^{+0.007} _{-0.007}	0.09 ^{+0.01} _{-0.02}	1.56 ^{+0.06} _{-0.13}	-	-	(0.6 ± 0.3) × 10 ⁻³	29.89	33
70102-01-25-00	2002-05-25, 07:16:50	1312.0	0.415 ^{+0.007} _{-0.007}	0.07 ^{+0.03} _{-0.02}	1.50 ^{+0.12} _{-0.13}	-	-	(0.9 ± 0.3) × 10 ⁻³	19.68	31
70102-01-26-00	2002-05-29, 00:27:27	1424.0	0.438 ^{+0.006} _{-0.006}	0.108 ± 0.006	1.63 ± 0.03	-	-	(0.7 ± 0.2) × 10 ⁻³	27.72	32
70102-01-27-00	2002-06-01, 08:40:53	1264.0	0.417 ^{+0.007} _{-0.006}	0.092 ± 0.006	1.58 ± 0.03	-	-	(0.7 ± 0.3) × 10 ⁻³	31.54	31
70102-01-28-00	2002-06-05, 14:31:43	1376.0	0.470 ^{+0.007} _{-0.006}	0.105 ± 0.006	1.58 ± 0.03	-	-	(0.8 ± 0.3) × 10 ⁻³	26.20	33

ObsID	t _{start}	Exposure [s]	Flux [keV/s/cm ²]	Powerlaw norm	Powerlaw Γ	Disk norm	Disk Temperature [keV]	Gauss area photons/s/cm ²	χ^2	Degrees of freedom
70102-01-29-00	2002-06-08, 12:14:07	1248.0	0.507 ^{+0.008} _{-0.007}	0.114 ± 0.006	1.58 ± 0.03	-	-	(0.5 ± 0.3) × 10 ⁻³	29.19	33
70102-01-30-00	2002-06-12, 11:12:20	1152.0	0.538 ^{+0.008} _{-0.007}	0.12 ^{+0.01} _{-0.03}	1.59 ^{+0.04} _{-0.12}	-	-	(0.6 ± 0.3) × 10 ⁻³	23.42	33
70102-01-31-00	2002-06-16, 19:14:23	1408.0	0.537 ^{+0.008} _{-0.007}	0.117 ± 0.006	1.57 ± 0.03	-	-	(0.7 ± 0.3) × 10 ⁻³	35.07	35
70102-01-32-00	2002-06-20, 12:09:22	1696.0	0.525 ^{+0.007} _{-0.007}	0.12 ^{+0.01} _{-0.03}	1.60 ^{+0.03} _{-0.10}	-	-	(0.5 ^{+0.3} _{-0.2}) × 10 ⁻³	31.01	35
70102-01-33-00	2002-06-25, 10:51:43	1488.0	0.579 ^{+0.008} _{-0.007}	0.13 ^{+0.02} _{-0.03}	1.58 ^{+0.05} _{-0.10}	-	-	(0.4 ± 0.3) × 10 ⁻³	34.48	35
70102-01-34-00	2002-06-27, 23:12:59	1552.0	0.601 ^{+0.008} _{-0.007}	0.12 ^{+0.02} _{-0.03}	1.54 ^{+0.07} _{-0.12}	-	-	(0.9 ± 0.3) × 10 ⁻³	29.91	35
70102-01-35-00	2002-06-30, 22:30:29	1280.0	0.595 ^{+0.008} _{-0.007}	0.12 ^{+0.03} _{-0.03}	1.55 ^{+0.11} _{-0.13}	-	-	(0.8 ± 0.3) × 10 ⁻³	27.94	34
70102-01-36-00	2002-07-02, 20:25:19	784.0	0.609 ^{+0.011} _{-0.010}	0.11 ^{+0.04} _{-0.03}	1.49 ^{+0.13} _{-0.14}	-	-	(0.8 ^{+0.5} _{-0.4}) × 10 ⁻³	39.38	31
70102-01-37-00	2002-07-06, 11:29:56	1088.0	0.588 ^{+0.009} _{-0.008}	0.13 ^{+0.01} _{-0.03}	1.59 ^{+0.04} _{-0.12}	-	-	(0.7 ^{+0.4} _{-0.3}) × 10 ⁻³	26.50	34
70102-01-38-00	2002-07-10, 18:10:23	1824.0	0.573 ^{+0.007} _{-0.006}	0.11 ± 0.02	1.52 ^{+0.08} _{-0.09}	-	-	(0.9 ± 0.3) × 10 ⁻³	25.05	35
70102-01-39-00	2002-07-13, 05:57:19	1632.0	0.632 ^{+0.008} _{-0.010}	0.142 ± 0.006	1.58 ± 0.02	-	-	(0.9 ± 0.3) × 10 ⁻³	32.37	35
70102-01-40-00	2002-07-16, 23:09:35	1024.0	0.670 ^{+0.009} _{-0.007}	0.166 ± 0.009	1.63 ± 0.03	-	-	(1.2 ± 0.4) × 10 ⁻³	24.17	33
70102-01-41-00	2002-07-19, 19:02:23	1424.0	0.696 ^{+0.009} _{-0.007}	0.14 ± 0.03	1.55 ^{+0.07} _{-0.09}	-	-	(0.7 ± 0.3) × 10 ⁻³	22.98	35
70102-01-42-00	2002-07-24, 09:22:26	1344.0	0.662 ^{+0.009} _{-0.007}	0.16 ^{+0.01} _{-0.01}	1.60 ^{+0.03} _{-0.03}	-	-	(0.5 ± 0.3) × 10 ⁻³	21.74	35
70102-01-43-00	2005-01-31, 09:42:23	1520.0	0.594 ^{+0.007} _{-0.007}	0.17 ^{+0.01} _{-0.02}	1.70 ^{+0.03} _{-0.06}	-	-	(0.6 ± 0.3) × 10 ⁻³	28.29	36
70102-01-44-00	2002-08-01, 13:44:31	1536.0	0.720 ^{+0.008} _{-0.007}	0.17 ± 0.04	1.62 ^{+0.08} _{-0.09}	-	-	(1.1 ± 0.3) × 10 ⁻³	54.58	35
70102-01-45-00	2002-08-02, 04:28:53	1264.0	0.729 ^{+0.008} _{-0.010}	0.19 ^{+0.04} _{-0.05}	1.66 ^{+0.13} _{-0.12}	-	-	(1.0 ± 0.4) × 10 ⁻³	28.06	34
70102-01-46-00	2002-08-07, 06:09:20	1200.0	0.744 ^{+0.008} _{-0.008}	0.199 ± 0.009	1.66 ± 0.02	-	-	(0.8 ± 0.3) × 10 ⁻³	35.10	35
70102-01-47-00	2002-08-09, 10:30:18	1456.0	0.694 ^{+0.009} _{-0.008}	0.185 ± 0.008	1.66 ± 0.02	-	-	(0.6 ± 0.3) × 10 ⁻³	23.86	34
70102-01-48-00	2002-08-13, 12:39:18	1584.0	0.617 ^{+0.007} _{-0.007}	0.15 ± 0.03	1.63 ^{+0.02} _{-0.09}	-	-	(0.8 ± 0.3) × 10 ⁻³	31.36	34
70102-01-49-00	2002-08-18, 04:38:23	1440.0	0.621 ^{+0.007} _{-0.007}	0.153 ± 0.007	1.62 ± 0.02	-	-	(0.5 ± 0.3) × 10 ⁻³	41.94	34
70102-01-50-00	2002-08-22, 05:14:10	1424.0	0.671 ^{+0.008} _{-0.008}	0.172 ± 0.008	1.64 ± 0.02	-	-	(0.7 ± 0.3) × 10 ⁻³	46.77	35
70102-01-51-00	2002-08-23, 04:56:41	1440.0	0.670 ^{+0.007} _{-0.007}	0.16 ^{+0.01} _{-0.03}	1.62 ^{+0.03} _{-0.10}	-	-	(0.6 ± 0.3) × 10 ⁻³	35.86	35
70102-01-52-00	2005-02-10, 23:00:17	1360.0	0.591 ^{+0.008} _{-0.007}	0.13 ^{+0.04} _{-0.03}	1.59 ± 0.11	-	-	(0.6 ± 0.3) × 10 ⁻³	26.51	35
70102-01-53-00	2002-09-01, 18:46:49	1008.0	0.562 ^{+0.009} _{-0.008}	0.131 ± 0.008	1.60 ± 0.03	-	-	(0.7 ± 0.3) × 10 ⁻³	28.58	33
70102-01-54-00	2002-09-04, 23:40:51	1520.0	0.584 ^{+0.008} _{-0.008}	0.10 ^{+0.03} _{-0.02}	1.45 ^{+0.11} _{-0.10}	-	-	(0.9 ± 0.3) × 10 ⁻³	25.19	34
70102-01-55-00	2002-09-07, 10:47:18	1168.0	0.627 ^{+0.009} _{-0.008}	0.149 ^{+0.008} _{-0.007}	1.61 ± 0.03	-	-	(1.1 ± 0.3) × 10 ⁻³	38.59	33
70102-01-56-00	2002-09-10, 22:42:05	768.0	0.672 ^{+0.010} _{-0.009}	0.161 ^{+0.007} _{-0.009}	1.61 ± 0.03	-	-	(0.7 ± 0.4) × 10 ⁻³	34.25	33
70102-01-57-00	2002-09-15, 08:34:17	1344.0	0.636 ^{+0.009} _{-0.007}	0.14 ^{+0.01} _{-0.03}	1.56 ^{+0.04} _{-0.10}	-	-	(1.1 ± 0.4) × 10 ⁻³	32.15	35
70102-01-58-00	2002-09-18, 07:48:10	1232.0	0.594 ^{+0.009} _{-0.007}	0.130 ± 0.007	1.57 ± 0.03	-	-	(0.6 ± 0.3) × 10 ⁻³	42.49	34
70102-01-59-00	2002-09-21, 13:22:17	1120.0	0.592 ^{+0.009} _{-0.009}	0.129 ± 0.007	1.57 ± 0.03	-	-	(²⁺³ ₋₂) × 10 ⁻⁴	37.39	34
70102-01-60-00	2002-09-24, 23:23:18	1408.0	0.641 ^{+0.009} _{-0.007}	0.14 ^{+0.01} _{-0.02}	1.56 ^{+0.02} _{-0.07}	-	-	(0.7 ± 0.3) × 10 ⁻³	41.12	34
70102-01-61-00	2002-09-27, 09:56:18	1424.0	0.681 ^{+0.009} _{-0.007}	0.154 ± 0.007	1.58 ± 0.02	-	-	(0.4 ± 0.3) × 10 ⁻³	31.98	35
70102-01-62-00	2002-10-01, 05:40:51	1600.0	0.677 ^{+0.008} _{-0.008}	0.154 ^{+0.007} _{-0.006}	1.59 ± 0.02	-	-	(0.6 ± 0.3) × 10 ⁻³	30.60	35
70102-01-63-00	2002-10-05, 04:32:07	1536.0	0.656 ^{+0.008} _{-0.007}	0.11 ^{+0.03} _{-0.02}	1.47 ^{+0.10} _{-0.09}	-	-	(0.7 ± 0.3) × 10 ⁻³	31.63	35
70102-01-64-00	2002-10-08, 22:22:28	1328.0	0.631 ^{+0.009} _{-0.007}	0.15 ^{+0.01} _{-0.03}	1.61 ^{+0.03} _{-0.11}	-	-	(0.4 ± 0.3) × 10 ⁻³	38.16	35
70102-01-65-00	2002-10-13, 02:11:59	1472.0	0.697 ^{+0.007} _{-0.007}	0.168 ± 0.007	1.61 ± 0.02	-	-	(0.9 ± 0.3) × 10 ⁻³	35.57	35
70102-01-66-00	2005-02-06, 21:31:27	1584.0	0.565 ^{+0.006} _{-0.006}	0.14 ^{+0.02} _{-0.03}	1.64 ^{+0.06} _{-0.10}	-	-	(0.6 ± 0.3) × 10 ⁻³	31.80	34
70102-01-67-00	2002-10-18, 22:44:31	1456.0	0.753 ^{+0.009} _{-0.007}	0.15 ^{+0.04} _{-0.03}	1.55 ^{+0.09} _{-0.08}	-	-	(1.0 ± 0.3) × 10 ⁻³	46.38	36
70102-01-68-00	2002-10-21, 21:51:59	1408.0	0.779 ^{+0.007} _{-0.007}	0.215 ^{+0.008} _{-0.008}	1.68 ± 0.02	-	-	(0.7 ± 0.3) × 10 ⁻³	26.59	36
70102-01-69-00	2002-10-27, 23:50:24	1328.0	0.656 ^{+0.009} _{-0.007}	0.13 ± 0.03	1.54 ± 0.09	-	-	(0.7 ± 0.3) × 10 ⁻³	37.34	36

ObsID	t _{start}	Exposure [s]	Flux [keV/s/cm ²]	Powerlaw norm	Powerlaw Γ	Disk norm	Disk Temperature [keV]	Gauss area photons/s/cm ²	χ^2	Degrees of freedom
70102-01-70-00	2005-02-12, 07:42:15	1408.0	0.577 ^{+0.008} _{-0.010}	0.13 ± 0.03	1.59 ^{+0.08} _{-0.10}	-	-	(0.4 ± 0.3) × 10 ⁻³	24.94	36
70102-01-71-00	2002-11-02, 17:26:41	1072.0	0.716 ^{+0.010} _{-0.008}	0.16 ± 0.04	1.60 ^{+0.08} _{-0.10}	-	-	(1.2 ± 0.4) × 10 ⁻³	36.48	35
70102-01-72-00	2002-11-06, 16:10:42	1408.0	0.690 ^{+0.008} _{-0.005}	0.182 ± 0.008	1.66 ± 0.02	-	-	(1.3 ± 0.3) × 10 ⁻³	39.34	36
70102-01-73-00	2002-11-10, 22:51:26	1808.0	0.670 ^{+0.005} _{-0.005}	0.17 ^{+0.02} _{-0.03}	1.63 ^{+0.05} _{-0.09}	-	-	(0.7 ± 0.3) × 10 ⁻³	32.02	36
70102-01-74-00	2002-11-13, 14:18:33	1200.0	0.628 ^{+0.009} _{-0.007}	0.13 ± 0.03	1.54 ± 0.10	-	-	(0.8 ± 0.3) × 10 ⁻³	30.66	35
70102-01-75-00	2002-11-16, 09:49:35	1408.0	0.633 ^{+0.006} _{-0.007}	0.159 ± 0.007	1.63 ± 0.02	-	-	(0.8 ± 0.3) × 10 ⁻³	41.34	35
70102-01-76-00	2002-11-20, 06:04:15	992.0	0.660 ^{+0.010} _{-0.008}	0.13 ^{+0.03} _{-0.04}	1.54 ^{+0.08} _{-0.12}	-	-	(1.2 ± 0.4) × 10 ⁻³	21.34	34
70102-01-77-00	2002-11-22, 00:21:35	1392.0	0.670 ^{+0.008} _{-0.007}	0.173 ^{+0.008} _{-0.007}	1.65 ± 0.02	-	-	(0.7 ± 0.3) × 10 ⁻³	23.72	36
70102-01-78-00	2003-01-20, 20:23:43	2320.0	0.593 ^{+0.006} _{-0.005}	0.15 ^{+0.02} _{-0.03}	1.66 ^{+0.06} _{-0.09}	-	-	(0.5 ^{+0.3} _{-0.2}) × 10 ⁻³	14.56	36
70102-01-79-00	2003-01-23, 18:04:26	1152.0	0.576 ^{+0.008} _{-0.007}	0.18 ^{+0.01} _{-0.03}	1.74 ^{+0.06} _{-0.06}	-	-	(0.6 ± 0.3) × 10 ⁻³	23.91	34
70102-01-80-00	2003-01-25, 15:39:18	1376.0	0.562 ^{+0.008} _{-0.006}	0.18 ^{+0.01} _{-0.04}	1.75 ^{+0.03} _{-0.10}	-	-	(0.7 ± 0.3) × 10 ⁻³	30.02	34
70102-01-81-00	2003-01-29, 16:03:48	1376.0	0.568 ^{+0.008} _{-0.006}	0.1903 ± 0.0018	1.77 ^{+0.01} _{-0.09}	-	-	(0.4 ^{+0.2} _{-0.3}) × 10 ⁻³	23.54	35
70102-01-83-00	2003-02-06, 01:17:19	1408.0	0.622 ^{+0.009} _{-0.007}	0.45 ^{+0.07} _{-0.10}	2.16 ^{+0.06} _{-0.11}	(0.3 ^{+0.7} _{-0.2}) × 10 ³	0.6 ^{+0.3} _{-0.1}	(0.9 ± 0.4) × 10 ⁻³	37.91	32
70102-01-84-00	2003-02-09, 22:29:19	1424.0	0.332 ^{+0.005} _{-0.006}	0.17 ^{+0.05} _{-0.06}	2.17 ^{+0.13} _{-0.17}	(1.0 ^{+0.0} _{-0.3}) × 10 ³	0.60 ^{+0.04} _{-0.01}	(0.6 ± 0.3) × 10 ⁻³	13.31	26
70102-01-85-00	2003-02-13, 10:20:31	1152.0	0.238 ^{+0.006} _{-0.005}	0.08 ^{+0.04} _{-0.03}	2.02 ± 0.19	(1.00 ^{+0.00} _{-0.15}) × 10 ³	0.593 ^{+0.015} _{-0.007}	(0.7 ± 0.3) × 10 ⁻³	22.60	20
70102-01-86-00	2003-02-15, 03:07:41	1520.0	0.204 ± 0.005	0.09 ^{+0.05} _{-0.03}	2.2 ± 0.2	(1.00 ^{+0.00} _{-0.16}) × 10 ³	0.586 ^{+0.017} _{-0.007}	(0.6 ± 0.2) × 10 ⁻³	23.54	19
70102-01-87-00	2003-02-19, 05:03:33	1280.0	0.172 ± 0.005	0.05 ^{+0.03} _{-0.02}	2.0 ± 0.3	(1.00 ^{+0.00} _{-0.17}) × 10 ³	0.579 ^{+0.017} _{-0.007}	(0.6 ± 0.2) × 10 ⁻³	26.26	18
70102-01-88-00	2003-02-21, 07:57:16	896.0	0.147 ^{+0.005} _{-0.006}	0.05 ^{+0.06} _{-0.03}	2.1 ± 0.4	(1.0 ^{+0.0} _{-0.3}) × 10 ³	0.57 ^{+0.03} _{-0.01}	(0.5 ± 0.3) × 10 ⁻³	9.69	14
70102-01-89-00	2003-02-24, 21:00:18	1744.0	0.154 ± 0.004	0.07 ^{+0.05} _{-0.03}	2.2 ^{+0.2} _{-0.3}	(1.0 ^{+0.0} _{-0.3}) × 10 ³	0.56 ^{+0.03} _{-0.01}	(0.45 ± 0.19) × 10 ⁻³	14.24	18
70102-01-90-00	2005-02-17, 00:01:17	1360.0	0.521 ^{+0.007} _{-0.007}	0.13 ^{+0.01} _{-0.02}	1.59 ^{+0.04} _{-0.09}	(1.0 ^{+0.0} _{-0.3}) × 10 ³	-	(0.6 ± 0.3) × 10 ⁻³	19.52	34
80102-01-01-00	2003-04-26, 12:30:09	1408.0	0.240 ± 0.006	0.16 ^{+0.08} _{-0.05}	2.17 ^{+0.19} _{-0.17}	(0.3 ^{+0.7} _{-0.2}) × 10 ³	0.60 ^{+0.10} _{-0.11}	(0.7 ^{+0.2} _{-0.2}) × 10 ⁻³	26.54	24
80102-01-02-00	2003-04-30, 17:52:15	1328.0	0.319 ^{+0.006} _{-0.005}	0.128 ^{+0.002} _{-0.014}	1.86 ± 0.05	-	-	(0.5 ^{+0.3} _{-0.2}) × 10 ⁻³	18.24	30
80102-01-03-00	2003-05-03, 19:30:43	1504.0	0.315 ^{+0.006} _{-0.005}	0.11 ^{+0.01} _{-0.04}	1.79 ^{+0.09} _{-0.17}	-	-	(0.5 ± 0.2) × 10 ⁻³	44.90	31
80102-01-04-00	2003-05-06, 23:48:21	1344.0	0.323 ^{+0.006} _{-0.005}	0.15 ^{+0.01} _{-0.06}	1.9 ^{+0.0} _{-0.2}	-	-	(0.5 ^{+0.3} _{-0.2}) × 10 ⁻³	14.96	29
80102-01-05-00	2003-05-12, 17:09:20	1136.0	0.351 ^{+0.007} _{-0.006}	0.20 ^{+0.02} _{-0.03}	2.02 ^{+0.06} _{-0.07}	-	-	(0.5 ± 0.3) × 10 ⁻³	35.68	28
80102-01-06-00	2003-05-14, 09:40:31	1456.0	0.355 ^{+0.006} _{-0.005}	0.25 ^{+0.03} _{-0.03}	2.12 ^{+0.05} _{-0.07}	-	-	(0.4 ± 0.3) × 10 ⁻³	20.64	30
80102-01-07-00	2003-05-17, 23:18:29	1456.0	0.360 ^{+0.005} _{-0.005}	0.19 ^{+0.04} _{-0.06}	2.00 ^{+0.08} _{-0.14}	-	-	(0.4 ± 0.3) × 10 ⁻³	38.96	31
80102-01-08-00	2003-05-20, 20:36:33	1456.0	0.362 ^{+0.006} _{-0.005}	0.20 ^{+0.07} _{-0.08}	2.0 ^{+0.1} _{-0.2}	-	-	(1 ⁺³ ₋₁) × 10 ⁻⁴	22.83	30
80102-01-09-00	2003-05-24, 00:30:23	1424.0	0.359 ^{+0.006} _{-0.005}	0.28 ^{+0.04} _{-0.12}	2.2 ^{+0.1} _{-0.2}	-	-	(0.4 ^{+0.3} _{-0.2}) × 10 ⁻³	18.97	29
80102-01-10-00	2003-05-29, 08:22:16	1296.0	0.282 ^{+0.004} _{-0.006}	0.29 ^{+0.05} _{-0.06}	2.35 ^{+0.08} _{-0.10}	(1.0 ^{+0.0} _{-0.8}) × 10 ³	0.49 ^{+0.11} _{-0.02}	(0.4 ± 0.3) × 10 ⁻³	12.37	23
80102-01-11-00	2003-06-01, 07:15:26	1424.0	0.301 ^{+0.006} _{-0.005}	0.29 ^{+0.05} _{-0.06}	2.32 ^{+0.07} _{-0.10}	(1.0 ^{+0.0} _{-0.8}) × 10 ³	0.48 ^{+0.14} _{-0.02}	(0.4 ^{+0.3} _{-0.2}) × 10 ⁻³	23.49	26
80102-01-12-00	2003-06-06, 18:26:55	1264.0	0.320 ± 0.006	0.112 ± 0.008	1.79 ± 0.04	-	-	(2 ± 2) × 10 ⁻⁴	18.23	29
80102-01-13-00	2003-06-09, 07:46:43	1168.0	0.312 ^{+0.007} _{-0.006}	0.099 ^{+0.008} _{-0.007}	1.74 ± 0.04	-	-	(0.3 ± 0.2) × 10 ⁻³	22.16	29
80102-01-14-00	2003-06-11, 13:33:51	1360.0	0.328 ± 0.006	0.08 ± 0.03	1.64 ^{+0.14} _{-0.17}	-	-	(0.5 ± 0.2) × 10 ⁻³	29.73	32
80102-01-15-00	2003-06-13, 07:53:35	1488.0	0.326 ^{+0.006} _{-0.005}	0.10 ^{+0.01} _{-0.04}	1.74 ^{+0.17} _{-0.17}	-	-	(0.5 ± 0.2) × 10 ⁻³	47.74	31
80102-01-16-00	2003-06-19, 05:43:11	1520.0	0.354 ^{+0.006} _{-0.005}	0.09 ^{+0.04} _{-0.03}	1.65 ^{+0.17} _{-0.16}	-	-	(0.7 ^{+0.3} _{-0.2}) × 10 ⁻³	30.72	32
80102-01-17-00	2003-06-22, 08:02:40	1376.0	0.353 ^{+0.007} _{-0.006}	0.08 ^{+0.04} _{-0.03}	1.61 ± 0.17	-	-	(0.7 ± 0.3) × 10 ⁻³	22.87	31
80102-01-18-00	2003-06-26, 08:17:35	1472.0	0.380 ^{+0.007} _{-0.006}	0.122 ^{+0.008} _{-0.007}	1.75 ± 0.03	-	-	(0.7 ± 0.2) × 10 ⁻³	24.15	31
80102-01-19-00	2003-06-28, 05:57:10	1344.0	0.378 ^{+0.006} _{-0.005}	0.10 ^{+0.02} _{-0.03}	1.68 ^{+0.08} _{-0.16}	-	-	(0.6 ± 0.3) × 10 ⁻³	35.46	31
80102-01-20-00	2003-07-01, 21:15:27	1248.0	0.377 ^{+0.007} _{-0.006}	0.10 ^{+0.02} _{-0.03}	1.68 ^{+0.09} _{-0.17}	-	-	(0.4 ± 0.3) × 10 ⁻³	37.40	31
80102-01-21-00	2003-07-06, 04:49:35	1360.0	0.354 ^{+0.007} _{-0.006}	0.096 ^{+0.007} _{-0.006}	1.67 ± 0.04	-	-	(0.4 ± 0.2) × 10 ⁻³	23.03	31

ObsID	t_{start}	Exposure [s]	Flux [keV/s/cm ²]	Powerlaw norm	Powerlaw Γ	Disk norm	Disk Temperature [keV]	Gauss area photons/s/cm ²	χ^2	Degrees of freedom
80102-01-22-00	2003-07-09, 20:08:06	1328.0	0.384 ^{+0.007} _{-0.006}	0.10 ^{+0.02} _{-0.03}	1.66 ^{+0.09} _{-0.16}	-	-	(0.5 ± 0.3) × 10 ⁻³	31.19	32
80102-01-23-00	2003-07-13, 20:18:58	1520.0	0.427 ^{+0.007} _{-0.006}	0.120 ± 0.007	1.68 ± 0.03	-	-	(0.4 ± 0.2) × 10 ⁻³	18.41	33
80102-01-24-00	2003-07-17, 00:08:42	1168.0	0.419 ^{+0.008} _{-0.007}	0.11 ^{+0.01} _{-0.03}	1.67 ^{+0.05} _{-0.11}	-	-	(0.6 ± 0.3) × 10 ⁻³	23.75	32
80102-01-25-00	2003-07-19, 23:04:31	1280.0	0.403 ^{+0.007} _{-0.006}	0.09 ± 0.03	1.60 ^{+0.11} _{-0.15}	-	-	(0.6 ± 0.3) × 10 ⁻³	30.77	32
80102-01-26-00	2003-07-23, 13:53:41	1344.0	0.435 ^{+0.007} _{-0.006}	0.111 ± 0.007	1.64 ± 0.03	-	-	(0.4 ± 0.3) × 10 ⁻³	26.10	33
80102-01-27-00	2003-07-26, 05:04:07	1216.0	0.456 ^{+0.007} _{-0.007}	0.123 ^{+0.008} _{-0.007}	1.67 ± 0.03	-	-	(0.7 ± 0.3) × 10 ⁻³	22.28	32
80102-01-28-00	2003-07-29, 19:50:30	1376.0	0.483 ± 0.007	0.10 ^{+0.03} _{-0.02}	1.55 ^{+0.13} _{-0.12}	-	-	(0.9 ± 0.3) × 10 ⁻³	27.53	33
80102-01-29-00	2003-08-03, 19:49:17	1232.0	0.498 ± 0.008	0.137 ± 0.008	1.68 ± 0.03	-	-	(0.7 ± 0.3) × 10 ⁻³	27.85	33
80102-01-30-00	2005-02-25, 16:54:23	1568.0	0.547 ^{+0.007} _{-0.006}	0.11 ^{+0.03} _{-0.02}	1.55 ± 0.10	-	-	(0.8 ± 0.3) × 10 ⁻³	23.61	35
80102-01-31-00	2003-08-11, 16:39:27	1184.0	0.470 ^{+0.008} _{-0.007}	0.11 ^{+0.01} _{-0.03}	1.59 ^{+0.04} _{-0.14}	-	-	(0.6 ± 0.3) × 10 ⁻³	18.79	32
80102-01-32-00	2003-08-14, 08:02:18	1232.0	0.474 ^{+0.008} _{-0.008}	0.112 ± 0.007	1.61 ± 0.03	-	-	(0.8 ± 0.3) × 10 ⁻³	47.77	34
80102-01-33-00	2003-08-17, 08:36:18	1376.0	0.479 ^{+0.008} _{-0.008}	0.11 ^{+0.01} _{-0.03}	1.58 ^{+0.06} _{-0.12}	-	-	(0.6 ± 0.3) × 10 ⁻³	16.36	34
80102-01-34-00	2007-03-02, 10:24:49	1680.0	0.507 ^{+0.007} _{-0.006}	0.09 ^{+0.03} _{-0.02}	1.48 ± 0.10	-	-	(0.7 ± 0.3) × 10 ⁻³	29.02	35
80102-01-35-00	2003-08-22, 18:09:12	1136.0	0.499 ^{+0.007} _{-0.007}	0.119 ± 0.007	1.61 ± 0.03	-	-	(0.6 ± 0.3) × 10 ⁻³	34.36	33
80102-01-36-00	2003-08-28, 19:17:08	1072.0	0.544 ^{+0.007} _{-0.006}	0.15 ^{+0.01} _{-0.04}	1.67 ^{+0.05} _{-0.15}	-	-	(0.7 ± 0.4) × 10 ⁻³	32.50	33
80102-01-37-00	2003-08-29, 17:16:39	1408.0	0.554 ^{+0.008} _{-0.007}	0.153 ^{+0.008} _{-0.007}	1.68 ± 0.03	-	-	(0.8 ± 0.3) × 10 ⁻³	31.82	34
80102-01-38-00	2003-09-04, 15:06:39	1472.0	0.604 ^{+0.007} _{-0.007}	0.155 ± 0.007	1.64 ± 0.02	-	-	(0.8 ± 0.3) × 10 ⁻³	26.18	34
80102-01-39-00	2003-09-05, 19:39:37	1280.0	0.595 ^{+0.007} _{-0.007}	0.149 ± 0.008	1.63 ± 0.03	-	-	(0.8 ± 0.3) × 10 ⁻³	19.06	35
80102-01-40-00	2003-09-09, 14:56:31	1456.0	0.545 ^{+0.008} _{-0.008}	0.129 ^{+0.007} _{-0.007}	1.61 ± 0.03	-	-	(0.5 ± 0.3) × 10 ⁻³	23.64	34
80102-01-41-00	2003-09-12, 01:30:24	1360.0	0.506 ^{+0.007} _{-0.007}	0.11 ^{+0.06} _{-0.03}	1.58 ^{+0.07} _{-0.12}	-	-	(0.5 ± 0.3) × 10 ⁻³	12.90	34
80102-01-42-00	2003-09-16, 17:34:22	1280.0	0.558 ^{+0.008} _{-0.007}	0.13 ± 0.03	1.60 ^{+0.08} _{-0.11}	-	-	(0.6 ± 0.3) × 10 ⁻³	42.24	34
80102-01-43-00	2003-09-21, 14:17:17	1488.0	0.592 ^{+0.008} _{-0.008}	0.153 ± 0.007	1.65 ± 0.02	-	-	(0.8 ± 0.3) × 10 ⁻³	41.77	36
80102-01-44-00	2003-09-24, 03:30:49	1504.0	0.589 ^{+0.007} _{-0.007}	0.140 ^{+0.007} _{-0.006}	1.61 ± 0.02	-	-	(0.8 ± 0.3) × 10 ⁻³	33.48	36
80102-01-45-00	2003-09-29, 06:45:35	1440.0	0.584 ^{+0.008} _{-0.007}	0.14 ^{+0.02} _{-0.03}	1.62 ^{+0.05} _{-0.11}	-	-	(0.7 ± 0.3) × 10 ⁻³	26.13	35
80102-01-46-00	2003-10-01, 09:20:18	1344.0	0.573 ^{+0.007} _{-0.007}	0.141 ± 0.007	1.63 ± 0.03	-	-	(0.7 ± 0.3) × 10 ⁻³	41.56	34
80102-01-47-00	2006-01-20, 22:04:39	1408.0	0.696 ^{+0.008} _{-0.007}	0.175 ± 0.007	1.64 ± 0.02	-	-	(0.9 ± 0.3) × 10 ⁻³	32.31	36
80102-01-48-00	2003-10-09, 04:52:47	1296.0	0.587 ^{+0.008} _{-0.007}	0.15 ^{+0.01} _{-0.04}	1.64 ^{+0.03} _{-0.02}	-	-	(0.7 ± 0.3) × 10 ⁻³	25.24	35
80102-01-49-00	2003-10-14, 06:22:17	1536.0	0.637 ^{+0.007} _{-0.007}	0.17 ^{+0.02} _{-0.04}	1.66 ^{+0.05} _{-0.10}	-	-	(1.0 ± 0.3) × 10 ⁻³	53.53	35
80102-01-50-00	2003-10-16, 00:27:44	1456.0	0.633 ^{+0.008} _{-0.007}	0.180 ± 0.008	1.69 ± 0.02	-	-	(0.4 ± 0.3) × 10 ⁻³	37.69	34
80102-01-51-00	2003-10-19, 23:10:27	1408.0	0.631 ^{+0.008} _{-0.008}	0.177 ± 0.008	1.68 ± 0.02	-	-	(0.5 ± 0.3) × 10 ⁻³	16.95	35
80102-01-52-00	2003-10-23, 14:18:48	1440.0	0.576 ^{+0.008} _{-0.007}	0.155 ^{+0.008} _{-0.007}	1.67 ± 0.03	-	-	(0.5 ± 0.3) × 10 ⁻³	22.28	34
80102-01-53-00	2003-10-26, 00:43:33	1200.0	0.582 ^{+0.009} _{-0.007}	0.15 ^{+0.01} _{-0.02}	1.66 ^{+0.04} _{-0.06}	-	-	(0.8 ± 0.3) × 10 ⁻³	28.42	35
80102-01-54-00	2003-10-30, 05:32:18	1232.0	0.597 ^{+0.007} _{-0.007}	0.11 ^{+0.03} _{-0.03}	1.50 ± 0.11	-	-	(0.8 ± 0.3) × 10 ⁻³	39.84	35
80102-01-55-00	2003-11-03, 10:14:55	1328.0	0.596 ^{+0.008} _{-0.008}	0.10 ^{+0.04} _{-0.02}	1.48 ^{+0.13} _{-0.11}	-	-	(0.7 ± 0.3) × 10 ⁻³	46.07	36
80102-01-56-00	2003-11-05, 06:43:30	1328.0	0.569 ^{+0.008} _{-0.007}	0.141 ± 0.007	1.63 ± 0.03	-	-	(0.4 ± 0.3) × 10 ⁻³	33.45	33
80102-01-57-00	2003-11-08, 03:59:19	1696.0	0.521 ^{+0.007} _{-0.006}	0.125 ± 0.006	1.61 ± 0.02	-	-	(0.4 ± 0.2) × 10 ⁻³	27.62	35
80102-01-58-00	2003-11-12, 08:30:55	1424.0	0.521 ^{+0.008} _{-0.008}	0.131 ^{+0.007} _{-0.013}	1.63 ± 0.03	-	-	(0.6 ± 0.3) × 10 ⁻³	31.69	34
80102-01-59-00	2003-11-15, 04:47:36	1616.0	0.580 ^{+0.007} _{-0.007}	0.14 ^{+0.02} _{-0.03}	1.60 ^{+0.06} _{-0.04}	-	-	(0.5 ± 0.3) × 10 ⁻³	22.95	35
80102-01-60-00	2003-11-19, 15:33:03	1168.0	0.594 ^{+0.009} _{-0.009}	0.15 ^{+0.03} _{-0.05}	1.65 ^{+0.04} _{-0.15}	-	-	(0.6 ± 0.3) × 10 ⁻³	24.23	35
80102-01-61-00	2005-02-19, 22:48:17	1424.0	0.516 ^{+0.007} _{-0.006}	0.125 ± 0.006	1.62 ± 0.03	-	-	(0.5 ± 0.3) × 10 ⁻³	36.94	34
80102-01-62-00	2005-02-23, 19:30:16	1280.0	0.519 ^{+0.008} _{-0.007}	0.129 ± 0.007	1.63 ± 0.03	-	-	(0.8 ± 0.3) × 10 ⁻³	17.20	34

ObsID	t _{start}	Exposure [s]	Flux [keV/s/cm ²]	Powerlaw norm	Powerlaw Γ	Disk norm	Disk Temperature [keV]	Gauss area photons/s/cm ²	χ^2	Degrees of freedom
80102-01-63-00	2007-03-05, 21:47:18	1392.0	0.480 ^{+0.007} _{-0.006}	0.102 ^{+0.006} _{-0.005}	1.56 ± 0.03	-	-	(0.6 ± 0.3) × 10 ⁻³	49.38	35
80102-01-64-00	2007-03-10, 14:52:17	1088.0	0.430 ^{+0.008} _{-0.007}	0.09 ^{+0.02} _{-0.03}	1.55 ^{+0.08} _{-0.14}	-	-	(0.7 ± 0.3) × 10 ⁻³	24.24	32
80102-01-65-00	2007-03-15, 23:15:17	1344.0	0.463 ^{+0.006} _{-0.006}	0.08 ± 0.02	1.50 ^{+0.19} _{-0.04}	-	-	(0.7 ± 0.3) × 10 ⁻³	30.96	34
80102-01-66-00	2007-03-20, 18:25:18	1264.0	0.508 ^{+0.008} _{-0.008}	0.11 ± 0.01	1.56 ^{+0.04} _{-0.04}	-	-	(1.0 ± 0.3) × 10 ⁻³	35.88	34
80102-01-67-00	2007-03-22, 17:24:21	1632.0	0.526 ^{+0.007} _{-0.005}	0.12 ± 0.01	1.57 ^{+0.02} _{-0.05}	-	-	(0.5 ± 0.2) × 10 ⁻³	44.93	35
80102-01-68-00	2007-03-23, 12:00:06	1456.0	0.517 ^{+0.006} _{-0.006}	0.11 ± 0.02	1.55 ^{+0.11} _{-0.08}	-	-	(0.6 ± 0.3) × 10 ⁻³	33.20	35
80102-01-69-00	2007-03-29, 21:59:02	1376.0	0.478 ^{+0.007} _{-0.006}	0.09 ± 0.02	1.53 ^{+0.08} _{-0.11}	-	-	(0.5 ± 0.3) × 10 ⁻³	38.16	35
80102-01-70-00	2007-04-02, 23:52:47	1328.0	0.475 ^{+0.006} _{-0.007}	0.07 ^{+0.03} _{-0.02}	1.41 ± 0.13	-	-	(0.7 ± 0.3) × 10 ⁻³	31.05	35
80102-01-71-00	2007-04-04, 00:54:40	1568.0	0.488 ^{+0.007} _{-0.006}	0.11 ± 0.01	1.57 ^{+0.04} _{-0.11}	-	-	(0.6 ± 0.3) × 10 ⁻³	45.19	35
80102-01-72-00	2007-04-07, 02:52:03	1264.0	0.534 ^{+0.008} _{-0.007}	0.121 ± 0.006	1.58 ± 0.03	-	-	(0.4 ± 0.3) × 10 ⁻³	32.04	34
80102-01-73-00	2007-04-09, 23:50:23	1424.0	0.548 ^{+0.008} _{-0.008}	0.10 ± 0.03	1.49 ^{+0.11} _{-0.09}	-	-	(0.6 ± 0.3) × 10 ⁻³	23.73	36
80102-01-74-00	2007-04-13, 03:22:41	1312.0	0.506 ^{+0.007} _{-0.008}	0.10 ± 0.02	1.55 ^{+0.09} _{-0.12}	-	-	(0.6 ± 0.3) × 10 ⁻³	35.86	35
80102-01-75-00	2007-04-17, 01:31:40	1472.0	0.533 ^{+0.008} _{-0.006}	0.10 ± 0.02	1.53 ^{+0.07} _{-0.11}	-	-	(0.8 ± 0.3) × 10 ⁻³	26.28	34
80102-01-76-00	2007-04-24, 17:24:53	1488.0	0.607 ^{+0.006} _{-0.006}	0.15 ± 0.02	1.64 ^{+0.15} _{-0.12}	-	-	(0.6 ± 0.3) × 10 ⁻³	22.86	36
80102-01-77-00	2004-01-22, 16:27:43	1248.0	0.573 ^{+0.007} _{-0.008}	0.11 ± 0.04	1.54 ^{+0.12} _{-0.11}	-	-	(1.1 ± 0.3) × 10 ⁻³	33.58	35
80102-01-78-00	2004-01-21, 03:03:37	1616.0	0.587 ^{+0.007} _{-0.008}	0.14 ± 0.03	1.61 ± 0.09	-	-	(0.8 ± 0.3) × 10 ⁻³	37.09	35
80102-01-79-00	2004-01-25, 03:17:11	1248.0	0.589 ^{+0.007} _{-0.008}	0.17 ± 0.02	1.70 ^{+0.10} _{-0.11}	-	-	(0.8 ± 0.3) × 10 ⁻³	24.09	35
80102-01-80-00	2004-01-27, 07:15:58	1344.0	0.616 ^{+0.008} _{-0.007}	0.17 ± 0.03	1.68 ^{+0.07} _{-0.12}	-	-	(0.5 ^{+0.4} _{-0.3}) × 10 ⁻³	19.89	35
80102-01-81-00	2004-02-01, 03:41:19	1488.0	0.615 ^{+0.008} _{-0.009}	0.17 ± 0.04	1.68 ^{+0.07} _{-0.10}	-	-	(0.5 ± 0.3) × 10 ⁻³	32.66	35
80102-01-82-00	2004-02-03, 15:41:17	1552.0	0.607 ^{+0.007} _{-0.008}	0.174 ± 0.008	1.70 ± 0.02	-	-	(0.7 ± 0.3) × 10 ⁻³	36.35	36
80102-01-83-00	2004-02-07, 12:45:19	1248.0	0.590 ^{+0.007} _{-0.008}	0.21 ± 0.02	1.79 ^{+0.04} _{-0.08}	-	-	(0.7 ± 0.3) × 10 ⁻³	34.78	33
80102-01-84-00	2004-02-12, 04:22:23	1728.0	0.576 ^{+0.007} _{-0.006}	0.15 ± 0.04	1.66 ^{+0.11} _{-0.10}	-	-	(0.8 ± 0.3) × 10 ⁻³	29.39	36
80102-01-85-00	2004-02-16, 08:00:16	1168.0	0.572 ^{+0.007} _{-0.007}	0.20 ± 0.03	1.79 ^{+0.13} _{-0.10}	-	-	(0.4 ± 0.3) × 10 ⁻³	21.40	35
80102-01-86-00	2004-02-18, 14:50:41	1680.0	0.560 ^{+0.007} _{-0.006}	0.18 ± 0.05	1.74 ^{+0.03} _{-0.12}	-	-	(0.7 ± 0.3) × 10 ⁻³	27.06	35
80102-01-87-00	2004-02-20, 03:15:59	1392.0	0.556 ^{+0.007} _{-0.006}	0.169 ± 0.008	1.72 ± 0.02	-	-	(0.7 ± 0.3) × 10 ⁻³	22.83	34
80102-01-88-00	2007-04-20, 05:02:23	1312.0	0.542 ^{+0.006} _{-0.007}	0.137 ± 0.007	1.63 ± 0.03	-	-	(0.3 ± 0.3) × 10 ⁻³	24.15	35
80102-01-89-00	2007-05-29, 11:37:57	1488.0	0.599 ^{+0.007} _{-0.006}	0.18 ± 0.04	1.73 ^{+0.07} _{-0.11}	-	-	(0.7 ± 0.3) × 10 ⁻³	24.40	35
80102-01-90-00	2007-06-12, 02:31:27	1088.0	0.535 ^{+0.008} _{-0.007}	0.188 ± 0.011	1.79 ± 0.03	-	-	(0.5 ± 0.3) × 10 ⁻³	38.63	32
90102-01-01-00	2004-03-03, 22:43:11	1344.0	0.512 ^{+0.008} _{-0.007}	0.151 ± 0.008	1.71 ± 0.03	-	-	(0.5 ± 0.3) × 10 ⁻³	21.26	34
90102-01-02-00	2004-02-28, 03:40:14	1216.0	0.517 ^{+0.008} _{-0.007}	0.152 ± 0.008	1.71 ± 0.03	-	-	(0.3 ± 0.3) × 10 ⁻³	41.55	34
90102-01-03-00	2004-03-06, 16:31:27	1440.0	0.526 ^{+0.007} _{-0.007}	0.165 ± 0.008	1.74 ± 0.03	-	-	(0.6 ± 0.3) × 10 ⁻³	32.73	34
90102-01-04-00	2004-03-10, 23:13:52	1456.0	0.529 ^{+0.007} _{-0.007}	0.14 ± 0.05	1.68 ^{+0.11} _{-0.12}	-	-	(0.7 ± 0.3) × 10 ⁻³	27.23	35
90102-01-05-00	2004-03-14, 04:29:35	1232.0	0.498 ^{+0.008} _{-0.007}	0.15 ± 0.01	1.71 ^{+0.04} _{-0.08}	-	-	(0.5 ± 0.3) × 10 ⁻³	24.40	34
90102-01-06-00	2004-03-18, 13:40:39	1088.0	0.490 ^{+0.007} _{-0.007}	0.154 ± 0.009	1.74 ± 0.03	-	-	(0.6 ± 0.3) × 10 ⁻³	23.03	33
90102-01-07-00	2004-03-20, 03:49:07	1376.0	0.505 ^{+0.007} _{-0.006}	0.153 ± 0.008	1.72 ± 0.03	-	-	(0.6 ± 0.3) × 10 ⁻³	30.60	34
90102-01-08-00	2004-03-25, 03:30:37	1536.0	0.490 ^{+0.007} _{-0.008}	0.13 ± 0.01	1.67 ^{+0.05} _{-0.13}	-	-	(0.5 ± 0.3) × 10 ⁻³	33.21	33
90102-01-09-00	2004-03-27, 05:59:51	1264.0	0.492 ^{+0.008} _{-0.007}	0.12 ± 0.03	1.63 ^{+0.13} _{-0.13}	-	-	(0.6 ± 0.3) × 10 ⁻³	32.61	34
90102-01-10-00	2004-03-31, 02:48:07	1728.0	0.488 ^{+0.006} _{-0.005}	0.13 ± 0.03	1.66 ^{+0.10} _{-0.11}	-	-	(0.7 ^{+0.3} _{-0.2}) × 10 ⁻³	21.79	34
90102-01-11-00	2004-04-03, 12:55:17	1184.0	0.500 ^{+0.008} _{-0.007}	0.153 ± 0.008	1.73 ± 0.03	-	-	(0.4 ± 0.3) × 10 ⁻³	34.06	33
90102-01-12-00	2004-04-06, 21:18:17	1200.0	0.535 ^{+0.008} _{-0.007}	0.18 ± 0.01	1.78 ± 0.03	-	-	(0.8 ± 0.3) × 10 ⁻³	31.82	33
90102-01-13-00	2004-04-12, 09:27:17	1408.0	0.528 ^{+0.007} _{-0.006}	0.18 ± 0.03	1.76 ^{+0.02} _{-0.07}	-	-	(0.3 ± 0.3) × 10 ⁻³	43.89	35

ObsID	t _{start}	Exposure [s]	Flux [keV/s/cm ²]	Powerlaw norm	Powerlaw Γ	Disk norm	Disk Temperature [keV]	Gauss area photons/s/cm ²	χ^2	Degrees of freedom
90102-01-14-00	2006-01-24, 01:36:28	1248.0	0.748 ^{+0.009} _{-0.007}	0.20 ± 0.04	1.67 ^{+0.08} _{-0.10}	-	-	(0.6 ± 0.3) × 10 ⁻³	26.50	36
90102-01-15-00	2004-04-18, 20:03:17	1360.0	0.487 ^{+0.007} _{-0.006}	0.14 ± 0.03	1.72 ^{+0.08} _{-0.14}	-	-	(0.6 ± 0.3) × 10 ⁻³	32.55	33
90102-01-16-00	2004-04-21, 18:52:18	1584.0	0.487 ^{+0.007} _{-0.007}	0.17 ± 0.01	1.78 ^{+0.01} _{-0.04}	-	-	(0.5 ± 0.3) × 10 ⁻³	32.73	33
90102-01-17-00	2004-04-24, 17:44:18	1504.0	0.496 ^{+0.007} _{-0.006}	0.17 ± 0.01	1.78 ^{+0.01} _{-0.04}	-	-	(0.8 ± 0.3) × 10 ⁻³	30.75	33
90102-01-18-00	2004-04-28, 16:07:11	1712.0	0.507 ^{+0.006} _{-0.005}	0.198 ± 0.009	1.84 ± 0.02	-	-	(0.6 ± 0.2) × 10 ⁻³	23.83	35
90102-01-19-00	2004-05-03, 00:15:27	1424.0	0.476 ^{+0.006} _{-0.006}	0.167 ± 0.008	1.79 ± 0.03	-	-	(0.8 ± 0.3) × 10 ⁻³	25.83	34
90102-01-20-00	2004-05-06, 22:41:36	1520.0	0.451 ^{+0.007} _{-0.007}	0.141 ± 0.007	1.73 ± 0.03	-	-	(0.6 ± 0.2) × 10 ⁻³	32.13	34
90102-01-21-00	2004-05-08, 14:00:32	1280.0	0.446 ^{+0.006} _{-0.007}	0.14 ± 0.02	1.75 ^{+0.07} _{-0.05}	-	-	(0.7 ± 0.3) × 10 ⁻³	28.95	34
90102-01-22-00	2004-05-13, 01:16:31	1328.0	0.467 ^{+0.006} _{-0.006}	0.19 ± 0.05	1.86 ^{+0.01} _{-0.05}	-	-	(0.5 ± 0.3) × 10 ⁻³	36.00	33
90102-01-23-00	2004-05-16, 00:04:40	1440.0	0.470 ^{+0.006} _{-0.006}	0.19 ± 0.05	1.85 ^{+0.04} _{-0.08}	-	-	(1.0 ± 0.3) × 10 ⁻³	28.55	34
90102-01-24-00	2004-05-19, 20:51:27	1536.0	0.462 ^{+0.007} _{-0.007}	0.16 ± 0.01	1.78 ^{+0.04} _{-0.04}	-	-	(0.7 ± 0.3) × 10 ⁻³	26.10	33
90102-01-25-00	2004-05-23, 11:47:21	1136.0	0.412 ^{+0.008} _{-0.008}	0.114 ± 0.012	1.68 ^{+0.05} _{-0.05}	-	-	(0.6 ± 0.3) × 10 ⁻³	26.65	30
90102-01-26-00	2004-05-25, 07:39:32	1232.0	0.394 ^{+0.007} _{-0.007}	0.114 ± 0.007	1.70 ± 0.03	-	-	(0.5 ± 0.3) × 10 ⁻³	20.76	32
90102-01-27-00	2004-05-28, 16:11:57	1456.0	0.417 ^{+0.006} _{-0.006}	0.113 ± 0.006	1.67 ± 0.03	-	-	(0.8 ± 0.2) × 10 ⁻³	33.84	33
90102-01-28-00	2004-06-02, 21:45:24	1072.0	0.430 ^{+0.008} _{-0.007}	0.08 ± 0.02	1.52 ^{+0.11} _{-0.14}	-	-	(0.4 ± 0.3) × 10 ⁻³	22.40	33
90102-01-29-00	2004-06-06, 14:25:03	1344.0	0.413 ^{+0.006} _{-0.006}	0.09 ± 0.02	1.55 ^{+0.07} _{-0.13}	-	-	(2 ⁺³ ₋₂) × 10 ⁻⁴	23.16	34
90102-01-30-00	2004-06-09, 14:54:07	1424.0	0.407 ^{+0.007} _{-0.007}	0.10 ± 0.01	1.62 ^{+0.04} _{-0.15}	-	-	(0.7 ± 0.3) × 10 ⁻³	25.97	33
90102-01-31-00	2004-06-11, 05:45:58	1424.0	0.402 ^{+0.006} _{-0.006}	0.094 ± 0.005	1.60 ± 0.03	-	-	(0.6 ± 0.2) × 10 ⁻³	28.32	33
90102-01-32-00	2004-06-15, 00:12:06	960.0	0.431 ^{+0.009} _{-0.008}	0.09 ± 0.02	1.57 ^{+0.07} _{-0.17}	-	-	(0.6 ± 0.4) × 10 ⁻³	22.61	31
90102-01-33-00	2004-06-19, 20:39:15	1280.0	0.519 ^{+0.008} _{-0.007}	0.13 ± 0.01	1.63 ^{+0.03} _{-0.12}	-	-	(0.6 ± 0.3) × 10 ⁻³	22.33	34
90102-01-34-00	2004-06-22, 09:45:06	1472.0	0.527 ^{+0.008} _{-0.008}	0.12 ± 0.01	1.58 ^{+0.04} _{-0.04}	-	-	(0.9 ± 0.3) × 10 ⁻³	27.47	35
90102-01-35-00	2004-06-25, 10:27:24	1504.0	0.536 ^{+0.008} _{-0.007}	0.11 ± 0.03	1.56 ^{+0.03} _{-0.03}	-	-	(0.7 ± 0.3) × 10 ⁻³	28.39	35
90102-01-36-00	2004-06-30, 08:31:10	1664.0	0.497 ^{+0.007} _{-0.006}	0.09 ± 0.03	1.49 ^{+0.11} _{-0.10}	-	-	(0.6 ± 0.3) × 10 ⁻³	29.85	34
90102-01-37-00	2004-07-02, 17:06:48	1520.0	0.518 ^{+0.007} _{-0.007}	0.13 ± 0.01	1.64 ^{+0.05} _{-0.11}	-	-	(0.8 ± 0.3) × 10 ⁻³	26.41	34
90102-01-38-00	2004-07-06, 23:42:23	1248.0	0.556 ^{+0.008} _{-0.007}	0.145 ± 0.008	1.65 ± 0.03	-	-	(0.7 ± 0.3) × 10 ⁻³	35.89	34
90102-01-39-00	2004-07-10, 12:44:37	1296.0	0.578 ^{+0.008} _{-0.007}	0.13 ± 0.02	1.59 ^{+0.06} _{-0.11}	-	-	(0.8 ± 0.3) × 10 ⁻³	31.95	34
90102-01-40-00	2004-07-12, 11:57:25	1440.0	0.592 ^{+0.007} _{-0.007}	0.12 ± 0.03	1.54 ^{+0.10} _{-0.10}	-	-	(0.8 ± 0.3) × 10 ⁻³	36.87	35
90102-01-41-00	2004-07-16, 10:31:51	1296.0	0.540 ^{+0.008} _{-0.007}	0.14 ± 0.01	1.63 ^{+0.04} _{-0.12}	-	-	(0.7 ± 0.3) × 10 ⁻³	25.73	34
90102-01-42-00	2004-07-22, 23:36:37	1456.0	0.592 ^{+0.008} _{-0.007}	0.15 ± 0.01	1.63 ^{+0.03} _{-0.14}	-	-	(0.8 ± 0.4) × 10 ⁻³	25.86	35
90102-01-43-00	2004-07-27, 17:31:52	1216.0	0.673 ^{+0.009} _{-0.009}	0.19 ± 0.01	1.69 ^{+0.03} _{-0.11}	-	-	(0.8 ± 0.3) × 10 ⁻³	27.37	36
90102-01-44-00	2004-07-29, 08:41:29	1136.0	0.672 ^{+0.008} _{-0.008}	0.222 ± 0.011	1.70 ± 0.03	-	-	(0.9 ± 0.3) × 10 ⁻³	25.71	34
90102-01-45-00	2004-07-31, 01:15:00	1376.0	0.658 ^{+0.008} _{-0.007}	0.18 ± 0.06	1.68 ± 0.11	-	-	(0.9 ± 0.3) × 10 ⁻³	34.03	34
90102-01-46-00	2004-08-05, 17:14:20	1296.0	0.617 ^{+0.008} _{-0.007}	0.21 ± 0.01	1.78 ^{+0.03} _{-0.13}	-	-	(0.8 ± 0.4) × 10 ⁻³	20.33	35
90102-01-47-00	2004-08-11, 03:28:22	1344.0	0.611 ^{+0.008} _{-0.007}	0.16 ± 0.05	1.68 ^{+0.11} _{-0.12}	-	-	(0.8 ± 0.4) × 10 ⁻³	30.92	35
90102-01-48-00	2004-08-12, 10:53:41	1440.0	0.606 ^{+0.008} _{-0.007}	0.188 ± 0.009	1.73 ± 0.02	-	-	(0.6 ± 0.3) × 10 ⁻³	35.41	33
90102-01-49-00	2004-08-16, 04:48:09	1408.0	0.614 ^{+0.007} _{-0.007}	0.19 ± 0.04	1.75 ^{+0.09} _{-0.12}	-	-	(0.7 ± 0.4) × 10 ⁻³	34.27	34
90102-01-50-00	2004-08-19, 18:12:34	1328.0	0.583 ^{+0.008} _{-0.007}	0.209 ± 0.010	1.80 ± 0.03	-	-	(0.7 ± 0.3) × 10 ⁻³	29.97	33
90102-01-51-00	2004-08-21, 17:24:51	1456.0	0.569 ^{+0.008} _{-0.007}	0.19 ± 0.03	1.77 ± 0.06	-	-	(0.4 ± 0.3) × 10 ⁻³	15.68	32
90102-01-52-00	2004-08-23, 18:14:47	1376.0	0.544 ^{+0.007} _{-0.007}	0.206 ± 0.011	1.83 ± 0.03	-	-	(0.6 ± 0.3) × 10 ⁻³	38.65	32
90102-01-53-00	2004-08-28, 19:28:33	1440.0	0.542 ^{+0.008} _{-0.007}	0.16 ± 0.03	1.71 ± 0.07	-	-	(0.6 ± 0.3) × 10 ⁻³	32.59	34
90102-01-54-00	2004-09-01, 08:33:25	1312.0	0.536 ^{+0.008} _{-0.007}	0.19 ± 0.01	1.80 ^{+0.04} _{-0.08}	-	-	(0.7 ± 0.3) × 10 ⁻³	28.64	33

ObsID	t_start	Exposure [s]	Flux [keV/s/cm ²]	Powerlaw norm	Powerlaw Γ	Disk norm	Disk Temperature [keV]	Gauss area photons/s/cm ²	χ^2	Degrees of freedom
90102-01-55-00	2004-09-07, 09:19:17	1360.0	0.525 ^{+0.008} _{-0.007}	0.200 ^{+0.011} _{-0.010}	1.83 ± 0.03	-	-	(0.5 ± 0.3) × 10 ⁻³	32.53	34
90102-01-56-00	2004-09-04, 12:12:11	1184.0	0.554 ^{+0.008} _{-0.007}	0.24 ^{+0.05} _{-0.16}	1.90 ^{+0.08} _{-0.16}	-	-	(0.8 ± 0.3) × 10 ⁻³	15.78	32
90102-01-57-00	2004-09-12, 22:48:05	1360.0	0.460 ^{+0.007} _{-0.007}	0.14 ^{+0.03} _{-0.09}	1.73 ^{+0.04} _{-0.09}	-	-	(0.9 ± 0.3) × 10 ⁻³	27.42	32
90102-01-58-00	2004-09-16, 22:57:19	1472.0	0.463 ^{+0.007} _{-0.007}	0.119 ^{+0.007} _{-0.006}	1.65 ± 0.03	-	-	(0.8 ± 0.3) × 10 ⁻³	25.70	34
90102-01-59-00	2004-09-18, 23:46:15	1424.0	0.468 ^{+0.007} _{-0.006}	0.10 ± 0.03	1.58 ^{+0.10} _{-0.12}	-	-	(0.8 ± 0.3) × 10 ⁻³	35.48	34
90102-01-60-00	2004-09-23, 06:28:17	1312.0	0.471 ^{+0.007} _{-0.007}	0.125 ± 0.007	1.66 ± 0.03	-	-	(0.3 ± 0.3) × 10 ⁻³	30.43	32
90102-01-61-00	2004-09-26, 14:51:18	1472.0	0.458 ^{+0.007} _{-0.006}	0.130 ± 0.007	1.69 ± 0.03	-	-	(0.6 ± 0.3) × 10 ⁻³	21.35	32
90102-01-62-00	2004-09-29, 00:40:24	1472.0	0.451 ^{+0.006} _{-0.008}	0.118 ^{+0.007} _{-0.006}	1.66 ± 0.03	-	-	(0.6 ± 0.3) × 10 ⁻³	33.23	33
90102-01-63-00	2004-10-04, 03:49:17	1264.0	0.479 ^{+0.007} _{-0.007}	0.119 ± 0.007	1.63 ± 0.03	-	-	(0.7 ± 0.3) × 10 ⁻³	28.87	33
90102-01-64-00	2004-10-01, 12:55:17	1520.0	0.457 ^{+0.006} _{-0.006}	0.120 ^{+0.007} _{-0.006}	1.65 ± 0.03	-	-	(0.8 ± 0.3) × 10 ⁻³	28.84	33
90102-01-65-00	2004-10-08, 00:22:56	1440.0	0.502 ^{+0.008} _{-0.007}	0.11 ± 0.02	1.57 ^{+0.09} _{-0.11}	-	-	(0.9 ± 0.3) × 10 ⁻³	29.06	34
90102-01-66-00	2004-10-13, 11:21:03	1440.0	0.472 ^{+0.007} _{-0.007}	0.113 ± 0.006	1.61 ± 0.03	-	-	(0.6 ± 0.3) × 10 ⁻³	32.85	34
90102-01-67-00	2004-10-16, 16:39:27	1296.0	0.460 ^{+0.006} _{-0.007}	0.11 ^{+0.02} _{-0.03}	1.60 ^{+0.07} _{-0.14}	-	-	(0.4 ± 0.3) × 10 ⁻³	30.37	33
90102-01-68-00	2004-10-20, 05:39:17	1392.0	0.513 ^{+0.007} _{-0.005}	0.12 ^{+0.03} _{-0.03}	1.60 ^{+0.03} _{-0.12}	-	-	(0.5 ± 0.3) × 10 ⁻³	29.76	35
90102-01-69-00	2004-10-24, 17:44:35	1344.0	0.540 ^{+0.007} _{-0.008}	0.135 ± 0.007	1.63 ± 0.03	-	-	(0.5 ± 0.3) × 10 ⁻³	32.66	34
90102-01-70-00	2004-10-22, 10:56:37	1456.0	0.528 ^{+0.008} _{-0.005}	0.14 ^{+0.01} _{-0.03}	1.65 ^{+0.03} _{-0.10}	-	-	(0.8 ± 0.3) × 10 ⁻³	24.12	34
90102-01-71-00	2004-10-29, 19:35:45	1392.0	0.525 ^{+0.007} _{-0.007}	0.13 ^{+0.03} _{-0.03}	1.61 ^{+0.03} _{-0.11}	-	-	(0.5 ± 0.3) × 10 ⁻³	33.30	35
90102-01-72-00	2004-11-04, 04:36:17	1616.0	0.525 ^{+0.006} _{-0.006}	0.127 ± 0.006	1.62 ± 0.03	-	-	(0.8 ± 0.3) × 10 ⁻³	24.24	34
90102-01-73-00	2004-11-06, 13:06:47	1696.0	0.522 ^{+0.007} _{-0.008}	0.116 ^{+0.001} _{-0.015}	1.58 ^{+0.04} _{-0.06}	-	-	(0.9 ± 0.3) × 10 ⁻³	43.32	35
90102-01-74-00	2004-11-10, 11:20:36	1424.0	0.528 ^{+0.007} _{-0.007}	0.118 ± 0.006	1.58 ± 0.03	-	-	(0.6 ± 0.3) × 10 ⁻³	26.94	34
90102-01-75-00	2004-11-12, 12:30:34	1232.0	0.535 ^{+0.008} _{-0.007}	0.10 ± 0.03	1.52 ^{+0.10} _{-0.12}	-	-	(0.5 ± 0.3) × 10 ⁻³	24.64	34
90102-01-76-00	2004-11-17, 19:39:33	1200.0	0.547 ^{+0.007} _{-0.007}	0.12 ^{+0.02} _{-0.03}	1.58 ^{+0.05} _{-0.12}	-	-	(0.3 ± 0.3) × 10 ⁻³	29.63	33
90102-01-77-00	2004-11-19, 22:01:05	1824.0	0.567 ^{+0.006} _{-0.007}	0.134 ± 0.006	1.60 ± 0.02	-	-	(0.5 ± 0.2) × 10 ⁻³	56.80	36
90102-01-78-00	2004-11-22, 00:23:12	1424.0	0.577 ^{+0.006} _{-0.007}	0.141 ± 0.007	1.62 ^{+0.03} _{-0.02}	-	-	(0.5 ± 0.3) × 10 ⁻³	29.43	35
90102-01-79-00	2006-01-27, 11:22:45	1328.0	0.729 ^{+0.007} _{-0.007}	0.19 ± 0.03	1.65 ^{+0.09} _{-0.09}	-	-	(0.5 ± 0.3) × 10 ⁻³	20.54	36
91105-01-01-00	2005-03-07, 05:29:20	1104.0	0.542 ^{+0.007} _{-0.008}	0.12 ± 0.04	1.60 ^{+0.13} _{-0.13}	-	-	(0.7 ± 0.3) × 10 ⁻³	24.06	34
91105-01-02-00	2005-03-10, 04:12:31	1424.0	0.547 ^{+0.007} _{-0.007}	0.13 ± 0.02	1.60 ^{+0.06} _{-0.11}	-	-	(0.5 ± 0.3) × 10 ⁻³	39.19	35
91105-01-03-00	2005-03-14, 19:52:07	1440.0	0.565 ^{+0.006} _{-0.007}	0.150 ± 0.007	1.66 ± 0.02	-	-	(0.7 ± 0.3) × 10 ⁻³	28.14	36
91105-01-04-00	2005-03-16, 06:34:57	1232.0	0.564 ^{+0.006} _{-0.007}	0.12 ± 0.03	1.55 ^{+0.09} _{-0.11}	-	-	(0.5 ± 0.3) × 10 ⁻³	22.22	35
91105-01-06-00	2005-03-24, 04:49:51	1520.0	0.561 ^{+0.007} _{-0.008}	0.13 ± 0.02	1.62 ^{+0.07} _{-0.10}	-	-	(0.7 ± 0.3) × 10 ⁻³	46.34	35
91105-01-07-00	2005-03-26, 18:20:53	1280.0	0.549 ^{+0.008} _{-0.007}	0.13 ± 0.03	1.62 ^{+0.10} _{-0.12}	-	-	(0.5 ± 0.3) × 10 ⁻³	26.28	35
91105-01-08-00	2005-03-31, 17:51:33	1456.0	0.564 ^{+0.007} _{-0.006}	0.147 ± 0.007	1.65 ± 0.02	-	-	(0.7 ± 0.3) × 10 ⁻³	35.10	36
91105-01-09-00	2005-04-02, 10:19:43	1504.0	0.543 ^{+0.006} _{-0.006}	0.10 ± 0.03	1.52 ± 0.10	-	-	(0.8 ± 0.3) × 10 ⁻³	34.51	36
91105-01-10-00	2007-08-27, 01:51:59	1360.0	0.306 ^{+0.007} _{-0.006}	0.11 ± 0.01	1.8 ^{+0.1} _{-0.2}	-	-	(0.5 ^{+0.3} _{-0.2}) × 10 ⁻³	23.09	29
91105-01-11-00	2005-04-11, 09:56:32	1440.0	0.505 ^{+0.007} _{-0.006}	0.10 ± 0.02	1.53 ^{+0.09} _{-0.10}	-	-	(0.7 ± 0.3) × 10 ⁻³	39.79	34
91105-01-12-00	2005-04-14, 18:39:52	1424.0	0.474 ^{+0.007} _{-0.006}	0.08 ± 0.03	1.47 ^{+0.14} _{-0.11}	-	-	(0.6 ± 0.3) × 10 ⁻³	32.49	35
91105-01-13-00	2005-04-18, 14:58:39	1408.0	0.508 ^{+0.006} _{-0.006}	0.117 ± 0.006	1.59 ± 0.03	-	-	(0.7 ± 0.3) × 10 ⁻³	42.35	34
91105-01-14-00	2005-04-21, 15:43:18	1312.0	0.577 ^{+0.007} _{-0.007}	0.137 ^{+0.007} _{-0.006}	1.61 ^{+0.03} _{-0.02}	-	-	(0.4 ± 0.3) × 10 ⁻³	38.34	35
91105-01-15-00	2005-04-25, 10:38:58	1424.0	0.598 ^{+0.008} _{-0.010}	0.15 ± 0.01	1.62 ± 0.02	-	-	(0.7 ± 0.3) × 10 ⁻³	36.48	36
91105-01-16-00	2005-04-26, 13:19:30	784.0	0.581 ^{+0.010} _{-0.010}	0.13 ± 0.03	1.58 ^{+0.08} _{-0.14}	-	-	(0.6 ± 0.4) × 10 ⁻³	37.61	33
91105-01-16-01	2005-04-26, 13:49:21	528.0	0.589 ^{+0.012} _{-0.011}	0.14 ± 0.01	1.61 ^{+0.05} _{-0.14}	-	-	(0.9 ± 0.5) × 10 ⁻³	28.92	31

ObsID	t _{start}	Exposure [s]	Flux [keV/s/cm ²]	Powerlaw norm	Powerlaw Γ	Disk norm	Disk Temperature [keV]	Gauss area photons/s/cm ²	χ^2	Degrees of freedom
91105-01-17-00	2005-04-30, 21:49:21	864.0	0.558 ^{+0.009} _{-0.008}	0.12 ± 0.03	1.57 ^{+0.10} _{-0.13}	-	-	(0.7 ± 0.4) × 10 ⁻³	26.21	33
91105-01-18-00	2005-05-04, 18:30:24	1328.0	0.527 ^{+0.008} _{-0.007}	0.08 ± 0.02	1.43 ^{+0.11} _{-0.10}	-	-	(0.9 ± 0.3) × 10 ⁻³	44.27	35
91105-01-19-00	2005-05-07, 01:31:27	1472.0	0.533 ^{+0.007} _{-0.007}	0.10 ± 0.02	1.51 ^{+0.09} _{-0.11}	-	-	(0.4 ± 0.3) × 10 ⁻³	39.27	35
91105-01-20-00	2005-05-08, 16:23:58	1456.0	0.531 ^{+0.007} _{-0.006}	0.09 ^{+0.03} _{-0.02}	1.48 ^{+0.11} _{-0.10}	-	-	(0.6 ± 0.3) × 10 ⁻³	31.38	35
91105-01-21-00	2005-05-16, 02:30:48	1328.0	0.676 ^{+0.008} _{-0.007}	0.14 ± 0.03	1.54 ± 0.09	-	-	(0.3 ± 0.3) × 10 ⁻³	32.86	36
91105-01-22-00	2005-05-19, 10:49:01	1424.0	0.619 ^{+0.007} _{-0.007}	0.158 ± 0.007	1.64 ± 0.02	-	-	(0.6 ± 0.3) × 10 ⁻³	30.62	36
91105-01-23-00	2007-05-21, 10:03:48	1536.0	0.582 ^{+0.007} _{-0.006}	0.12 ± 0.03	1.57 ± 0.10	-	-	(0.7 ± 0.3) × 10 ⁻³	46.14	36
91105-01-24-00	2005-05-26, 22:12:40	1344.0	0.657 ^{+0.008} _{-0.007}	0.184 ± 0.008	1.69 ± 0.02	-	-	(0.9 ± 0.3) × 10 ⁻³	33.23	36
91105-01-25-00	2005-05-28, 13:33:53	1168.0	0.659 ^{+0.007} _{-0.007}	0.19 ^{+0.03} _{-0.05}	1.70 ^{+0.06} _{-0.11}	-	-	(1.1 ± 0.3) × 10 ⁻³	36.57	35
91105-01-26-00	2007-09-02, 17:04:31	1248.0	0.298 ^{+0.006} _{-0.005}	0.24 ± 0.04	2.19 ^{+0.07} _{-0.09}	-	-	(0.3 ± 0.3) × 10 ⁻³	34.45	26
91105-01-27-00	2005-06-06, 07:56:35	1552.0	0.630 ^{+0.008} _{-0.008}	0.187 ± 0.008	1.71 ± 0.02	-	-	(0.6 ± 0.3) × 10 ⁻³	36.76	36
91105-01-28-00	2005-06-07, 12:14:07	1344.0	0.612 ^{+0.008} _{-0.007}	0.15 ^{+0.02} _{-0.04}	1.64 ± 0.05	-	-	(0.8 ± 0.3) × 10 ⁻³	26.31	36
91105-01-29-00	2005-06-13, 22:59:47	1072.0	0.573 ^{+0.009} _{-0.008}	0.153 ^{+0.009} _{-0.008}	1.66 ± 0.03	-	-	(0.6 ± 0.3) × 10 ⁻³	33.35	35
91105-01-30-00	2007-09-09, 15:29:35	1472.0	0.217 ^{+0.006} _{-0.005}	0.19 ^{+0.05} _{-0.04}	2.29 ^{+0.10} _{-0.12}	(1.0 ^{+0.0} _{-0.7}) × 10 ³	0.49 ^{+0.10} _{-0.02}	(0.8 ± 0.2) × 10 ⁻³	22.52	23
91105-01-31-00	2005-06-19, 05:49:38	1264.0	0.569 ^{+0.007} _{-0.007}	0.11 ± 0.03	1.54 ^{+0.11} _{-0.11}	-	-	(0.9 ± 0.3) × 10 ⁻³	29.57	33
91105-01-32-00	2005-06-21, 19:34:55	1328.0	0.564 ^{+0.008} _{-0.007}	0.135 ± 0.007	1.61 ± 0.03	-	-	(0.6 ± 0.3) × 10 ⁻³	46.87	35
91105-01-33-00	2005-06-27, 04:41:07	560.0	0.537 ^{+0.012} _{-0.011}	0.12 ^{+0.03} _{-0.04}	1.60 ^{+0.10} _{-0.18}	-	-	(0.4 ^{+0.5} _{-0.4}) × 10 ⁻³	27.01	30
91105-01-34-00	2005-06-29, 03:48:47	1424.0	0.567 ^{+0.008} _{-0.007}	0.12 ± 0.03	1.57 ^{+0.05} _{-0.10}	-	-	(0.7 ± 0.3) × 10 ⁻³	27.26	35
91105-01-35-00	2005-07-01, 01:29:24	1184.0	0.584 ^{+0.008} _{-0.007}	0.149 ± 0.008	1.64 ± 0.03	-	-	(0.8 ± 0.3) × 10 ⁻³	37.20	35
91105-01-36-00	2005-07-07, 14:50:04	1232.0	0.596 ^{+0.009} _{-0.007}	0.13 ± 0.03	1.58 ± 0.09	-	-	(0.4 ± 0.3) × 10 ⁻³	25.66	34
91105-01-37-00	2005-07-09, 05:59:40	1440.0	0.599 ^{+0.008} _{-0.007}	0.14 ^{+0.02} _{-0.03}	1.61 ± 0.06	-	-	(0.8 ± 0.3) × 10 ⁻³	31.46	35
91105-01-38-00	2005-07-12, 03:14:30	1408.0	0.575 ^{+0.007} _{-0.007}	0.12 ^{+0.03} _{-0.03}	1.56 ^{+0.11} _{-0.07}	-	-	(0.8 ± 0.3) × 10 ⁻³	24.67	35
91105-01-39-00	2005-07-16, 11:10:08	1152.0	0.563 ^{+0.009} _{-0.008}	0.13 ± 0.03	1.61 ± 0.04	-	-	(0.8 ± 0.3) × 10 ⁻³	36.41	35
91105-01-40-00	2005-07-19, 11:29:06	1408.0	0.562 ^{+0.008} _{-0.008}	0.11 ± 0.03	1.53 ± 0.12	-	-	(0.9 ± 0.3) × 10 ⁻³	24.20	35
91105-01-41-00	2005-07-23, 03:07:59	1392.0	0.583 ^{+0.008} _{-0.007}	0.11 ± 0.03	1.53 ± 0.10	-	-	(0.5 ± 0.3) × 10 ⁻³	30.00	36
91105-01-42-00	2005-07-26, 11:48:55	1504.0	0.601 ^{+0.008} _{-0.007}	0.148 ± 0.007	1.63 ± 0.02	-	-	(0.9 ± 0.3) × 10 ⁻³	24.09	36
91105-01-43-00	2005-07-29, 05:31:27	1376.0	0.596 ^{+0.007} _{-0.007}	0.14 ^{+0.01} _{-0.03}	1.60 ^{+0.04} _{-0.11}	-	-	(1.0 ± 0.3) × 10 ⁻³	36.30	34
91105-01-44-00	2007-09-18, 08:26:18	1360.0	0.287 ± 0.006	0.14 ^{+0.00} _{-0.02}	1.93 ^{+0.06} _{-0.08}	-	-	(0.5 ± 0.3) × 10 ⁻³	32.68	28
91105-01-45-00	2005-08-05, 20:27:33	1008.0	0.613 ^{+0.010} _{-0.008}	0.15 ± 0.01	1.62 ± 0.04	-	-	(0.5 ± 0.4) × 10 ⁻³	43.44	33
91105-01-46-00	2007-09-24, 10:09:35	1840.0	0.281 ± 0.005	0.17 ^{+0.02} _{-0.01}	2.05 ^{+0.04} _{-0.04}	-	-	(0.6 ± 0.2) × 10 ⁻³	21.30	29
91105-01-47-00	2005-08-12, 19:04:31	1344.0	0.635 ^{+0.009} _{-0.007}	0.16 ^{+0.02} _{-0.04}	1.65 ± 0.05	-	-	(0.6 ± 0.3) × 10 ⁻³	40.04	35
91105-01-48-00	2007-06-04, 19:54:59	1568.0	0.603 ^{+0.007} _{-0.006}	0.189 ± 0.008	1.74 ± 0.02	-	-	(0.6 ± 0.3) × 10 ⁻³	22.83	36
91105-01-49-00	2005-08-21, 21:39:27	1264.0	0.600 ^{+0.007} _{-0.007}	0.16 ^{+0.03} _{-0.04}	1.66 ± 0.08	-	-	(1.2 ^{+0.4} _{-0.3}) × 10 ⁻³	35.84	35
91105-01-50-00	2005-08-25, 17:03:17	928.0	0.610 ^{+0.009} _{-0.009}	0.156 ± 0.009	1.64 ± 0.03	-	-	(0.3 ^{+0.4} _{-0.3}) × 10 ⁻³	44.03	33
91105-01-51-00	2005-08-28, 09:19:17	1488.0	0.604 ^{+0.008} _{-0.007}	0.15 ^{+0.01} _{-0.03}	1.63 ± 0.03	-	-	(0.7 ± 0.3) × 10 ⁻³	36.62	36
91105-01-52-00	2007-09-30, 14:17:18	1328.0	0.209 ± 0.007	0.17 ± 0.07	2.3 ± 0.2	(0.2 ^{+0.8} _{-0.2}) × 10 ³	0.6 ^{+0.2} _{-0.1}	(0.3 ± 0.3) × 10 ⁻³	16.45	23
91105-01-53-00	2007-10-05, 22:40:36	1456.0	0.253 ^{+0.006} _{-0.005}	0.106 ^{+0.009} _{-0.008}	1.87 ± 0.05	-	-	(0.4 ± 0.2) × 10 ⁻³	18.32	27
91105-01-54-00	2005-09-07, 12:45:10	1360.0	0.493 ^{+0.007} _{-0.007}	0.116 ^{+0.006} _{-0.006}	1.60 ± 0.03	-	-	(0.9 ± 0.3) × 10 ⁻³	29.65	34
91105-01-55-00	2005-09-10, 07:16:31	1136.0	0.493 ^{+0.009} _{-0.008}	0.103 ^{+0.001} _{-0.014}	1.55 ± 0.01	-	-	(0.8 ± 0.3) × 10 ⁻³	26.36	32
91105-01-56-00	2005-09-15, 00:02:39	1248.0	0.520 ^{+0.008} _{-0.007}	0.120 ± 0.007	1.60 ± 0.03	-	-	(0.6 ± 0.3) × 10 ⁻³	31.19	34
91105-01-57-00	2005-09-21, 00:43:27	1536.0	0.533 ^{+0.006} _{-0.006}	0.10 ± 0.02	1.53 ± 0.10	-	-	(0.7 ± 0.3) × 10 ⁻³	35.10	35

ObsID	t _{start}	Exposure [s]	Flux [keV/s/cm ²]	Powerlaw norm	Powerlaw Γ	Disk norm	Disk Temperature [keV]	Gauss area photons/s/cm ²	χ^2	Degrees of freedom
91105-01-58-00	2005-09-18, 02:03:43	1424.0	0.529 ^{+0.008} _{-0.007}	0.105 ^{+0.006} _{-0.005}	1.53 ± 0.03	-	-	(0.7 ± 0.3) × 10 ⁻³	31.64	35
91105-01-59-00	2005-09-23, 16:13:11	1104.0	0.504 ^{+0.009} _{-0.008}	0.08 ^{+0.005} _{-0.02}	1.44 ± 0.13	-	-	(0.7 ± 0.3) × 10 ⁻³	26.91	33
91105-01-60-00	2005-09-29, 18:31:49	864.0	0.524 ^{+0.010} _{-0.007}	0.08 ^{+0.003} _{-0.02}	1.45 ± 0.13	-	-	(1.0 ± 0.4) × 10 ⁻³	28.32	31
91105-01-61-00	2007-10-15, 07:46:07	1152.0	0.247 ^{+0.007} _{-0.006}	0.06 ± 0.03	1.6 ^{+0.2} _{-0.3}	-	-	(0.8 ± 0.3) × 10 ⁻³	25.38	26
91105-01-62-00	2007-06-18, 04:32:53	1520.0	0.552 ^{+0.007} _{-0.006}	0.31 ^{+0.04} _{-0.06}	2.02 ± 0.06	-	-	(0.6 ± 0.3) × 10 ⁻³	37.19	34
91105-01-63-00	2007-10-20, 13:17:54	1440.0	0.258 ± 0.006	0.087 ^{+0.008} _{-0.007}	1.77 ± 0.04	-	-	(0.8 ± 0.2) × 10 ⁻³	27.27	29
91105-01-64-00	2005-10-11, 11:39:18	1424.0	0.558 ^{+0.008} _{-0.007}	0.12 ^{+0.02} _{-0.03}	1.55 ± 0.06	-	-	(0.6 ± 0.3) × 10 ⁻³	35.57	34
91105-01-65-00	2005-10-17, 20:29:28	1280.0	0.562 ^{+0.008} _{-0.007}	0.12 ^{+0.01} _{-0.02}	1.55 ± 0.05	-	-	(0.6 ± 0.3) × 10 ⁻³	27.99	35
91105-01-66-00	2005-10-20, 17:44:09	1232.0	0.622 ^{+0.009} _{-0.008}	0.12 ^{+0.03} _{-0.02}	1.52 ± 0.07	-	-	(0.9 ± 0.3) × 10 ⁻³	26.45	35
91105-01-67-00	2005-10-24, 23:39:51	1248.0	0.680 ^{+0.009} _{-0.008}	0.15 ^{+0.02} _{-0.03}	1.56 ± 0.06	-	-	(0.6 ± 0.3) × 10 ⁻³	19.58	36
91105-01-68-00	2005-10-27, 03:41:18	1328.0	0.673 ^{+0.009} _{-0.008}	0.147 ± 0.007	1.57 ± 0.02	-	-	(0.7 ± 0.3) × 10 ⁻³	33.20	35
91105-01-69-00	2005-10-29, 04:27:43	1488.0	0.634 ^{+0.008} _{-0.007}	0.139 ± 0.006	1.57 ± 0.02	-	-	(0.7 ± 0.3) × 10 ⁻³	23.13	35
91105-01-70-00	2005-11-02, 10:46:18	1472.0	0.574 ^{+0.008} _{-0.007}	0.117 ± 0.006	1.54 ± 0.03	-	-	(0.8 ± 0.3) × 10 ⁻³	28.25	36
91105-01-71-00	2005-11-05, 21:36:47	1472.0	0.588 ^{+0.008} _{-0.007}	0.130 ± 0.006	1.58 ± 0.02	-	-	(1.0 ± 0.3) × 10 ⁻³	30.13	35
91105-01-72-00	2005-11-08, 03:28:18	1376.0	0.634 ^{+0.008} _{-0.007}	0.1309 ± 0.0013	1.54 ± 0.01	-	-	(0.9 ± 0.3) × 10 ⁻³	24.18	36
91105-01-73-00	2007-10-28, 21:52:03	1488.0	0.286 ^{+0.006} _{-0.005}	0.10 ^{+0.02} _{-0.04}	1.8 ± 0.1	-	-	(0.5 ± 0.2) × 10 ⁻³	26.94	30
91105-01-74-00	2005-11-17, 09:09:51	1392.0	0.620 ^{+0.008} _{-0.007}	0.13 ^{+0.03} _{-0.03}	1.57 ± 0.10	-	-	(0.7 ± 0.3) × 10 ⁻³	23.56	35
91105-01-75-00	2005-11-18, 01:01:51	1280.0	0.617 ^{+0.009} _{-0.007}	0.14 ^{+0.00} _{-0.04}	1.59 ± 0.03	-	-	(0.4 ± 0.3) × 10 ⁻³	34.07	35
91105-01-76-00	2005-11-20, 06:11:09	1488.0	0.604 ^{+0.008} _{-0.007}	0.135 ± 0.006	1.58 ± 0.02	-	-	(0.9 ± 0.3) × 10 ⁻³	30.72	36
91105-01-77-00	2005-11-22, 05:07:12	1904.0	0.585 ^{+0.007} _{-0.006}	0.140 ± 0.006	1.61 ± 0.02	-	-	(0.6 ± 0.2) × 10 ⁻³	30.97	36
92095-01-01-00	2006-03-06, 12:51:28	1152.0	0.480 ^{+0.007} _{-0.007}	0.12 ^{+0.00} _{-0.03}	1.63 ± 0.03	-	-	(0.4 ± 0.3) × 10 ⁻³	26.37	34
92095-01-02-00	2006-03-08, 22:39:18	1536.0	0.475 ^{+0.007} _{-0.007}	0.10 ± 0.03	1.58 ± 0.12	-	-	(0.4 ± 0.3) × 10 ⁻³	30.89	36
92095-01-03-00	2006-03-13, 08:16:04	1328.0	0.473 ^{+0.007} _{-0.006}	0.126 ± 0.007	1.66 ± 0.03	-	-	(0.6 ± 0.3) × 10 ⁻³	29.44	34
92095-01-04-00	2006-03-16, 23:03:17	448.0	0.458 ^{+0.012} _{-0.011}	0.106 ± 0.002	1.60 ± 0.01	-	-	(0.8 ± 0.4) × 10 ⁻³	20.95	29
92095-01-05-00	2006-03-19, 07:20:15	1664.0	0.448 ± 0.006	0.09 ± 0.02	1.52 ± 0.11	-	-	(0.4 ± 0.2) × 10 ⁻³	28.61	35
92095-01-06-00	2006-03-23, 18:11:28	1504.0	0.425 ^{+0.007} _{-0.006}	0.096 ± 0.005	1.59 ± 0.03	-	-	(0.8 ± 0.2) × 10 ⁻³	41.08	33
92095-01-07-00	2006-03-27, 02:26:17	1552.0	0.419 ^{+0.007} _{-0.006}	0.09 ^{+0.01} _{-0.02}	1.57 ± 0.05	-	-	(0.7 ± 0.3) × 10 ⁻³	26.86	33
92095-01-08-00	2007-07-02, 14:13:11	1520.0	0.369 ^{+0.007} _{-0.007}	0.33 ^{+0.06} _{-0.03}	2.30 ± 0.08	-	0.52 ^{+0.11} _{-0.02}	(0.9 ± 0.3) × 10 ⁻³	18.74	27
92095-01-09-00	2006-03-31, 19:41:51	1488.0	0.461 ^{+0.007} _{-0.006}	0.10 ^{+0.03} _{-0.03}	1.57 ± 0.04	-	-	(0.8 ± 0.3) × 10 ⁻³	32.67	34
92095-01-10-00	2006-04-05, 05:07:27	1168.0	0.455 ^{+0.008} _{-0.007}	0.100 ± 0.001	1.57 ± 0.03	-	-	(0.4 ± 0.3) × 10 ⁻³	21.67	33
92095-01-11-00	2006-04-10, 13:35:59	1408.0	0.440 ^{+0.007} _{-0.007}	0.08 ± 0.02	1.52 ± 0.08	-	-	(0.7 ± 0.3) × 10 ⁻³	27.12	34
92095-01-12-00	2006-04-12, 22:33:35	1312.0	0.418 ^{+0.007} _{-0.006}	0.09 ± 0.01	1.58 ± 0.05	-	-	(0.7 ± 0.3) × 10 ⁻³	29.01	33
92095-01-13-00	2006-04-15, 00:46:43	1456.0	0.423 ^{+0.007} _{-0.006}	0.098 ± 0.006	1.60 ± 0.03	-	-	(0.7 ± 0.2) × 10 ⁻³	32.08	33
92095-01-14-00	2006-04-20, 23:48:05	768.0	0.468 ± 0.009	0.10 ^{+0.01} _{-0.02}	1.56 ± 0.04	-	-	(0.3 ^{+0.4} _{-0.3}) × 10 ⁻³	24.92	32
92095-01-14-01	2006-04-21, 00:03:10	720.0	0.458 ^{+0.010} _{-0.009}	0.08 ± 0.03	1.50 ± 0.17	-	-	(0.6 ± 0.4) × 10 ⁻³	32.85	32
92095-01-15-00	2006-04-24, 11:12:19	1280.0	0.495 ^{+0.008} _{-0.007}	0.10 ± 0.02	1.52 ± 0.08	-	-	(0.7 ± 0.3) × 10 ⁻³	33.49	34
92095-01-16-00	2006-04-27, 17:43:19	1488.0	0.469 ^{+0.007} _{-0.006}	0.09 ± 0.02	1.52 ± 0.09	-	-	(0.7 ± 0.3) × 10 ⁻³	32.08	34
92095-01-17-00	2006-04-28, 21:52:08	1440.0	0.468 ^{+0.009} _{-0.008}	0.08 ± 0.02	1.48 ± 0.11	-	-	(0.7 ± 0.3) × 10 ⁻³	27.97	34
92095-01-18-00	2006-05-04, 20:48:31	1664.0	0.488 ^{+0.009} _{-0.008}	0.10 ± 0.02	1.54 ± 0.09	-	-	(0.6 ± 0.3) × 10 ⁻³	20.57	35
92095-01-19-00	2006-05-08, 01:56:50	1568.0	0.535 ^{+0.007} _{-0.006}	0.13 ^{+0.01} _{-0.02}	1.62 ± 0.02	-	-	(0.3 ± 0.2) × 10 ⁻³	26.26	36
92095-01-20-00	2006-05-11, 02:21:39	1456.0	0.587 ^{+0.008} _{-0.006}	0.14 ^{+0.01} _{-0.03}	1.60 ± 0.04	-	-	(0.8 ± 0.3) × 10 ⁻³	36.68	35

ObsID	t _{start}	Exposure [s]	Flux [keV/s/cm ²]	Powerlaw norm	Powerlaw Γ	Disk norm	Disk Temperature [keV]	Gauss area photons/s/cm ²	χ^2	Degrees of freedom
92095-01-21-00	2006-05-12, 05:01:41	1280.0	0.589 ^{+0.008} _{-0.007}	0.13 ^{+0.02} _{-0.03}	1.59 ^{+0.07} _{-0.11}	-	-	(0.7 ± 0.3) × 10 ⁻³	35.05	36
92095-01-22-00	2007-07-10, 12:17:47	1440.0	0.360 ^{+0.006} _{-0.005}	0.35 ^{+0.04} _{-0.09}	2.29 ^{+0.06} _{-0.13}	-	-	(0.4 ± 0.3) × 10 ⁻³	35.16	28
92095-01-23-00	2006-05-22, 08:28:15	1392.0	0.512 ^{+0.007} _{-0.007}	0.12 ^{+0.02} _{-0.03}	1.59 ^{+0.07} _{-0.10}	-	-	(0.8 ± 0.3) × 10 ⁻³	30.79	35
92095-01-24-00	2006-05-23, 16:19:25	1520.0	0.507 ^{+0.007} _{-0.006}	0.10 ^{+0.02} _{-0.03}	1.53 ^{+0.10} _{-0.11}	-	-	(0.7 ± 0.3) × 10 ⁻³	34.83	35
92095-01-25-00	2006-05-28, 15:46:52	1488.0	0.562 ^{+0.007} _{-0.006}	0.13 ^{+0.01} _{-0.03}	1.59 ^{+0.05} _{-0.10}	-	-	(0.8 ± 0.3) × 10 ⁻³	31.13	35
92095-01-26-00	2007-07-15, 17:49:35	1472.0	0.285 ^{+0.008} _{-0.007}	0.17 ^{+0.11} _{-0.07}	2.1 ± 0.2	(0.1 ^{+0.5} _{-0.1}) × 10 ³	0.71 ^{+0.13} _{-0.18}	(0.8 ± 0.3) × 10 ⁻³	13.37	25
92095-01-27-00	2006-06-07, 22:35:27	1312.0	0.480 ^{+0.006} _{-0.007}	0.10 ± 0.02	1.54 ^{+0.07} _{-0.12}	-	-	(0.5 ± 0.3) × 10 ⁻³	21.94	35
92095-01-28-00	2006-06-02, 23:11:11	1152.0	0.522 ^{+0.008} _{-0.007}	0.11 ^{+0.02} _{-0.03}	1.57 ^{+0.08} _{-0.12}	-	-	(0.5 ± 0.3) × 10 ⁻³	30.42	34
92095-01-29-00	2006-06-09, 20:01:35	1456.0	0.476 ^{+0.007} _{-0.007}	0.09 ± 0.02	1.52 ^{+0.12} _{-0.13}	-	-	(0.8 ± 0.3) × 10 ⁻³	23.42	34
92095-01-30-00	2006-06-12, 21:58:23	1536.0	0.490 ^{+0.007} _{-0.006}	0.11 ^{+0.01} _{-0.03}	1.59 ^{+0.05} _{-0.10}	-	-	(0.9 ± 0.3) × 10 ⁻³	21.17	33
92095-01-31-00	2006-06-16, 20:11:27	1488.0	0.497 ^{+0.007} _{-0.006}	0.09 ± 0.02	1.49 ^{+0.13} _{-0.11}	-	-	(0.8 ± 0.3) × 10 ⁻³	21.61	34
92095-01-32-00	2006-06-20, 02:56:31	1040.0	0.570 ^{+0.009} _{-0.008}	0.13 ^{+0.02} _{-0.03}	1.59 ^{+0.06} _{-0.12}	-	-	(0.5 ± 0.3) × 10 ⁻³	25.80	34
92095-01-33-00	2006-06-23, 00:03:10	1456.0	0.544 ^{+0.007} _{-0.007}	0.112 ± 0.006	1.54 ± 0.03	-	-	(0.7 ± 0.3) × 10 ⁻³	42.99	34
92095-01-34-00	2006-06-28, 10:35:03	1232.0	0.495 ^{+0.008} _{-0.007}	0.107 ± 0.006	1.56 ± 0.03	-	-	(0.3 ± 0.3) × 10 ⁻³	32.62	33
92095-01-35-00	2006-07-01, 16:55:23	1424.0	0.540 ^{+0.007} _{-0.007}	0.120 ± 0.006	1.58 ± 0.03	-	-	(0.5 ± 0.3) × 10 ⁻³	34.68	34
92095-01-36-00	2007-07-23, 06:37:48	1296.0	0.294 ^{+0.008} _{-0.007}	0.21 ± 0.08	2.2 ^{+0.1} _{-0.2}	(0.1 ^{+0.9} _{-0.1}) × 10 ³	0.7 ± 0.2	(0.6 ± 0.3) × 10 ⁻³	14.05	25
92095-01-37-00	2006-07-08, 07:39:03	1376.0	0.655 ^{+0.009} _{-0.007}	0.171 ± 0.008	1.65 ± 0.02	-	-	(0.3 ± 0.3) × 10 ⁻³	33.26	36
92095-01-38-00	2006-07-12, 23:26:26	1168.0	0.655 ^{+0.009} _{-0.008}	0.18 ^{+0.03} _{-0.04}	1.68 ^{+0.06} _{-0.12}	-	-	(0.5 ± 0.4) × 10 ⁻³	26.19	35
92095-01-39-00	2006-07-16, 07:24:09	1344.0	0.640 ^{+0.007} _{-0.007}	0.186 ± 0.009	1.70 ± 0.02	-	-	(0.4 ± 0.3) × 10 ⁻³	25.22	34
92095-01-40-00	2006-07-19, 18:58:55	1152.0	0.618 ^{+0.009} _{-0.008}	0.209 ± 0.011	1.77 ± 0.03	-	-	(0.8 ± 0.3) × 10 ⁻³	18.92	32
92095-01-41-00	2006-07-22, 10:55:43	1456.0	0.626 ^{+0.008} _{-0.007}	0.17 ^{+0.02} _{-0.04}	1.69 ^{+0.04} _{-0.11}	-	-	(0.7 ± 0.3) × 10 ⁻³	18.11	35
92095-01-42-00	2007-07-30, 20:46:27	1536.0	0.305 ± 0.006	0.11 ^{+0.02} _{-0.04}	1.8 ± 0.3	-	-	(0.5 ^{+0.3} _{-0.2}) × 10 ⁻³	21.09	30
92095-01-43-00	2006-07-30, 19:03:43	1344.0	0.586 ^{+0.008} _{-0.007}	0.18 ^{+0.02} _{-0.06}	1.72 ^{+0.05} _{-0.15}	-	-	(0.7 ± 0.4) × 10 ⁻³	32.95	34
92095-01-44-00	2006-08-01, 18:08:43	1568.0	0.595 ^{+0.008} _{-0.006}	0.16 ± 0.04	1.69 ^{+0.09} _{-0.11}	-	-	(0.8 ± 0.3) × 10 ⁻³	25.61	35
92095-01-45-00	2006-08-04, 09:02:25	1344.0	0.581 ^{+0.008} _{-0.007}	0.27 ^{+0.02} _{-0.03}	1.93 ^{+0.04} _{-0.04}	-	-	(0.7 ± 0.3) × 10 ⁻³	26.45	33
92095-01-46-00	2006-08-05, 17:59:11	1504.0	0.583 ^{+0.007} _{-0.007}	0.34 ^{+0.03} _{-0.07}	2.04 ^{+0.10} _{-0.10}	-	-	(0.5 ^{+0.4} _{-0.3}) × 10 ⁻³	32.38	33
92095-01-47-00	2006-08-17, 19:25:19	976.0	0.544 ^{+0.007} _{-0.006}	0.21 ^{+0.04} _{-0.06}	1.85 ^{+0.07} _{-0.13}	-	-	(0.8 ± 0.3) × 10 ⁻³	29.24	34
92095-01-48-00	2007-08-05, 11:57:54	1312.0	0.292 ± 0.006	0.36 ^{+0.09} _{-0.15}	2.1 ^{+0.1} _{-0.2}	-	-	(0.3 ^{+0.4} _{-0.3}) × 10 ⁻³	17.07	30
92095-01-50-00	2006-08-24, 08:23:19	1520.0	0.460 ^{+0.006} _{-0.005}	0.09 ^{+0.03} _{-0.05}	1.7 ^{+0.1} _{-0.3}	-	-	(0.7 ± 0.3) × 10 ⁻³	21.80	30
92095-01-51-00	2006-08-27, 02:05:51	1680.0	0.427 ± 0.006	0.22 ^{+0.02} _{-0.03}	1.95 ^{+0.04} _{-0.05}	-	-	(0.5 ± 0.3) × 10 ⁻³	34.41	32
92095-01-52-00	2006-08-28, 23:38:40	1424.0	0.420 ^{+0.007} _{-0.006}	0.17 ^{+0.02} _{-0.05}	1.86 ^{+0.05} _{-0.15}	-	-	(0.5 ± 0.3) × 10 ⁻³	20.63	31
92095-01-53-00	2006-09-04, 06:43:43	1728.0	0.395 ^{+0.006} _{-0.007}	0.166 ^{+0.010} _{-0.009}	1.85 ± 0.03	-	-	(0.4 ± 0.3) × 10 ⁻³	35.44	32
92095-01-54-00	2006-09-06, 07:37:18	1328.0	0.375 ^{+0.006} _{-0.006}	0.15 ± 0.01	1.84 ± 0.03	-	-	(0.9 ^{+0.3} _{-0.2}) × 10 ⁻³	23.06	32
92095-01-55-00	2006-09-10, 00:46:42	1392.0	0.344 ^{+0.007} _{-0.006}	0.128 ^{+0.009} _{-0.008}	1.78 ± 0.04	-	-	(0.7 ± 0.3) × 10 ⁻³	15.43	30
92095-01-56-00	2006-09-14, 15:17:19	1408.0	0.352 ^{+0.007} _{-0.006}	0.107 ^{+0.008} _{-0.009}	1.73 ± 0.04	-	-	(0.4 ± 0.2) × 10 ⁻³	19.45	31
92095-01-57-00	2006-09-15, 23:46:57	1264.0	0.361 ^{+0.007} _{-0.007}	0.09 ± 0.01	1.67 ^{+0.07} _{-0.08}	-	-	(0.6 ± 0.3) × 10 ⁻³	23.15	30
92095-01-58-00	2006-09-18, 15:09:19	1408.0	0.367 ^{+0.007} _{-0.006}	0.10 ^{+0.01} _{-0.03}	1.71 ^{+0.06} _{-0.16}	-	-	(0.7 ± 0.3) × 10 ⁻³	32.02	31
92095-01-59-00	2006-09-23, 17:46:23	1248.0	0.355 ± 0.007	0.104 ± 0.007	1.69 ± 0.03	-	-	(0.5 ± 0.2) × 10 ⁻³	25.23	31
92095-01-60-00	2006-09-26, 18:03:36	1248.0	0.329 ^{+0.007} _{-0.006}	0.107 ± 0.008	1.72 ± 0.04	-	-	(0.6 ± 0.3) × 10 ⁻³	23.75	29
92095-01-61-00	2006-09-29, 00:58:18	1584.0	0.320 ± 0.006	0.08 ^{+0.02} _{-0.03}	1.62 ^{+0.10} _{-0.18}	-	-	(0.5 ± 0.3) × 10 ⁻³	22.52	30
				0.08 ^{+0.02} _{-0.03}	1.61 ^{+0.10} _{-0.17}	-	-	(0.5 ^{+0.3} _{-0.2}) × 10 ⁻³	22.32	31

ObsID	t _{start}	Exposure [s]	Flux [keV/s/cm ²]	Powerlaw norm	Powerlaw Γ	Disk norm	Disk Temperature [keV]	Gauss area photons/s/cm ²	χ^2	Degrees of freedom
92095-01-62-00	2006-10-03, 05:34:19	1568.0	0.326 ± 0.006	0.07 ± 0.02	1.54 ^{+0.10} _{-0.17}	-	-	(0.5 ± 0.3) × 10 ⁻³	19.18	32
92095-01-63-00	2006-10-08, 00:14:18	1600.0	0.340 ± 0.006	0.08 ^{+0.00} _{-0.03}	1.61 ^{+0.04} _{-0.16}	-	-	(0.5 ^{+0.3} _{-0.2}) × 10 ⁻³	27.40	32
92095-01-64-00	2006-10-12, 23:36:01	1360.0	0.364 ^{+0.007} _{-0.006}	0.087 ^{+0.006} _{-0.017}	1.61 ± 0.04	-	-	(0.6 ± 0.3) × 10 ⁻³	30.42	30
92095-01-65-00	2006-10-13, 09:16:18	1568.0	0.366 ^{+0.007} _{-0.006}	0.08 ^{+0.01} _{-0.03}	1.59 ^{+0.07} _{-0.15}	-	-	(0.6 ^{+0.3} _{-0.2}) × 10 ⁻³	39.15	33
92095-01-66-00	2006-10-16, 12:43:19	1568.0	0.356 ± 0.006	0.07 ± 0.02	1.51 ^{+0.13} _{-0.14}	-	-	(0.5 ^{+0.3} _{-0.2}) × 10 ⁻³	31.75	32
92095-01-67-00	2006-10-21, 19:32:15	1248.0	0.389 ± 0.007	0.090 ± 0.006	1.60 ± 0.04	-	-	(0.7 ± 0.3) × 10 ⁻³	25.66	31
92095-01-68-00	2006-10-26, 22:05:38	1424.0	0.410 ^{+0.007} _{-0.009}	0.10 ^{+0.00} _{-0.03}	1.62 ^{+0.01} _{-0.13}	-	-	(0.6 ± 0.2) × 10 ⁻³	31.02	33
92095-01-69-00	2006-10-28, 22:54:09	1408.0	0.410 ^{+0.006} _{-0.007}	0.103 ^{+0.007} _{-0.006}	1.63 ± 0.03	-	-	(0.3 ± 0.3) × 10 ⁻³	43.25	32
92095-01-70-00	2006-11-02, 03:53:20	1408.0	0.425 ^{+0.007} _{-0.006}	0.109 ^{+0.007} _{-0.006}	1.65 ± 0.03	-	-	(0.5 ± 0.3) × 10 ⁻³	21.51	32
92095-01-71-00	2006-11-06, 13:13:35	1200.0	0.401 ^{+0.008} _{-0.007}	0.097 ^{+0.007} _{-0.006}	1.62 ^{+0.04} _{-0.03}	-	-	(0.5 ± 0.3) × 10 ⁻³	17.18	32
92095-01-72-00	2006-11-07, 12:46:23	1296.0	0.387 ^{+0.007} _{-0.006}	0.10 ^{+0.00} _{-0.03}	1.62 ^{+0.03} _{-0.16}	-	-	(0.5 ± 0.3) × 10 ⁻³	21.99	32
92095-01-73-00	2006-11-11, 12:35:27	1408.0	0.407 ^{+0.006} _{-0.009}	0.108 ^{+0.007} _{-0.006}	1.66 ± 0.03	-	-	(0.5 ± 0.3) × 10 ⁻³	22.53	32
92095-01-74-00	2006-11-14, 20:39:40	1456.0	0.415 ^{+0.007} _{-0.008}	0.098 ± 0.006	1.61 ± 0.03	-	-	(0.5 ± 0.2) × 10 ⁻³	45.02	33
92095-01-75-00	2006-11-17, 13:07:27	1296.0	0.399 ^{+0.008} _{-0.007}	0.093 ± 0.006	1.60 ^{+0.04} _{-0.03}	-	-	(0.4 ± 0.3) × 10 ⁻³	25.88	31
92095-01-76-00	2006-11-22, 09:13:35	1408.0	0.409 ^{+0.007} _{-0.006}	0.106 ^{+0.007} _{-0.006}	1.65 ± 0.03	-	-	(0.6 ± 0.3) × 10 ⁻³	24.55	32
92095-01-77-00	2007-01-21, 04:08:35	1280.0	0.445 ± 0.007	0.09 ^{+0.01} _{-0.01}	1.55 ^{+0.03} _{-0.10}	-	-	(0.4 ± 0.3) × 10 ⁻³	19.58	33
92095-01-78-00	2007-01-24, 07:08:37	1744.0	0.467 ± 0.006	0.10 ^{+0.02} _{-0.01}	1.55 ^{+0.03} _{-0.10}	-	-	(0.5 ± 0.2) × 10 ⁻³	22.75	35
92095-01-79-00	2007-01-26, 22:25:03	1408.0	0.463 ^{+0.007} _{-0.009}	0.07 ^{+0.03} _{-0.02}	1.44 ^{+0.04} _{-0.11}	-	-	(0.7 ± 0.3) × 10 ⁻³	34.63	35
92095-01-80-00	2007-01-31, 21:48:31	1376.0	0.436 ^{+0.006} _{-0.006}	0.08 ^{+0.03} _{-0.02}	1.52 ± 0.13	-	-	(0.5 ± 0.3) × 10 ⁻³	26.31	34
92095-01-81-00	2007-02-02, 03:15:59	1424.0	0.442 ^{+0.007} _{-0.006}	0.07 ^{+0.03} _{-0.02}	1.45 ± 0.12	-	-	(0.6 ± 0.3) × 10 ⁻³	26.35	35
92095-01-82-00	2007-02-04, 23:17:17	1584.0	0.455 ^{+0.007} _{-0.006}	0.103 ^{+0.006} _{-0.005}	1.59 ± 0.03	-	-	(0.6 ± 0.2) × 10 ⁻³	34.09	34
92095-01-83-00	2007-02-10, 15:31:15	1584.0	0.488 ^{+0.009} _{-0.007}	0.105 ± 0.005	1.56 ± 0.03	-	-	(0.9 ± 0.2) × 10 ⁻³	22.78	36
92095-01-84-00	2007-02-12, 18:00:34	1344.0	0.509 ^{+0.008} _{-0.007}	0.11 ^{+0.01} _{-0.03}	1.55 ^{+0.05} _{-0.11}	-	-	(0.4 ± 0.3) × 10 ⁻³	29.51	35
92095-01-85-00	2007-02-16, 03:55:02	1664.0	0.507 ^{+0.007} _{-0.009}	0.12 ^{+0.01} _{-0.03}	1.60 ^{+0.05} _{-0.10}	-	-	(0.4 ± 0.3) × 10 ⁻³	32.77	35
92095-01-86-00	2007-02-19, 19:59:45	1312.0	0.456 ^{+0.009} _{-0.007}	0.09 ^{+0.03} _{-0.02}	1.54 ^{+0.10} _{-0.13}	-	-	(0.6 ± 0.3) × 10 ⁻³	24.81	32
92095-01-87-00	2007-02-23, 05:39:11	1440.0	0.473 ^{+0.007} _{-0.009}	0.111 ± 0.006	1.60 ± 0.03	-	-	(0.7 ± 0.3) × 10 ⁻³	19.61	34
92095-01-88-00	2007-03-01, 07:46:23	1424.0	0.519 ^{+0.007} _{-0.007}	0.108 ^{+0.006} _{-0.005}	1.55 ± 0.03	-	-	(0.6 ± 0.3) × 10 ⁻³	28.17	35
92095-01-89-00	2007-08-14, 03:05:09	1296.0	0.286 ^{+0.007} _{-0.006}	0.07 ± 0.03	1.7 ± 0.2	-	-	(0.7 ± 0.3) × 10 ⁻³	25.17	29
92095-01-90-00	2007-08-19, 10:37:19	1408.0	0.307 ± 0.006	0.09 ± 0.03	1.70 ^{+0.14} _{-0.19}	-	-	(0.7 ± 0.3) × 10 ⁻³	30.31	30

Bibliography

- Belloni T., (ed.) 2010, The Jet Paradigm, Vol. 794 of *Lecture Notes in Physics*, Berlin Springer Verlag, Lecture Notes in Physics, Berlin Springer Verlag
- Blandford R.D., Payne D.G., 1982, MNRAS 199, 883
- Blandford R.D., Znajek R.L., 1977, MNRAS 179, 433
- Carroll B.W., Ostlie D.A., 1996, An Introduction to Modern Astrophysics
- Carter B., 1971, Phys. Rev. Lett. 26, 331
- Chandrasekhar S., 1931, ApJ 74, 81
- Cohen M.H., Cannon W., Purcell G.H., et al., 1971, ApJ 170, 207
- Ebisawa K., Yamauchi S., Tanaka Y., et al., 2007, Progress of Theoretical Physics Supplement 169, 121
- Fender R.P., Belloni T.M., Gallo E., 2004, MNRAS 355, 1105
- Fürst F., Wilms J., Rothschild R.E., et al., 2009, Earth and Planetary Science Letters 281, 125
- Gruppen C., Shwartz B., 2008, Particle Detectors
- Horne J.H., Baliunas S.L., 1986, ApJ 302, 757
- Jahoda K., Markwardt C.B., Radeva Y., et al., 2006, ApJS 163, 401
- Jahoda K., Swank J.H., Giles A.B., et al., 1996, In: O. H. Siegmund & M. A. Gummin (ed.) Society of Photo-Optical Instrumentation Engineers (SPIE) Conference Series, Vol. 2808. Society of Photo-Optical Instrumentation Engineers (SPIE) Conference Series, p.59
- Karttunen H., Krüger P., Oja H., et al., (eds.) 2007, Fundamental Astronomy
- Koyama K., Tsunemi H., Dotani T., et al., 2007, PASJ 59, 23
- Kuznetsov S.I., Gilfanov M.R., Churazov E.M., et al., 1999, Astronomy Letters 25, 351
- Levine A.M., Bradt H., Cui W., et al., 1996, ApJL 469, L33
- Lin D., Smith I.A., Liang E.P., et al., 2000, ApJ 532, 548
- Lohfink A.M., Pottschmid K., Wilms J., et al., 2011, ApJ in prep.

- Main D.S., Smith D.M., Heindl W.A., et al., 1999, *ApJ* 525, 901
- Mandrour P., 1990, *IAU Circ.* 5032, 1
- Muñoz-Arjonilla A.J., Martí J., Luque-Escamilla P.L., et al., 2010, *A&A* 519, A15
- Nowak M., Hanke M., Trowbridge S.N., et al., 2010, In: *AAS/High Energy Astrophysics Division #11*, Vol. 42. *Bulletin of the American Astronomical Society*, p.733
- Oppenheimer J.R., Volkoff G.M., 1939, *Physical Review* 55, 374
- Peterson B.M., 1997, *An Introduction to Active Galactic Nuclei*
- Pottschmidt K., Chernyakova M., Lubiński P., et al., 2008, In: *Proceedings of the 7th INTEGRAL Workshop.*, p. 98
- Pottschmidt K., Chernyakova M., Zdziarski A.A., et al., 2006, In: A. Wilson (ed.) *The X-ray Universe 2005*. *ESA Special Publication* 604, p. 283
- Press W.H., Rybicki G.B., 1989, *ApJ* 338, 277
- Punsly B., Coroniti F.V., 1990, *ApJ* 354, 583
- Reid M.J., McClintock J.E., Narayan R., et al., 2011, *ArXiv e-prints*
- Remillard R.A., 2005, In: P. Chen, E. Bloom, G. Madejski, & V. Patrosian (ed.) *22nd Texas Symposium on Relativistic Astrophysics.*, p.79
- Remillard R.A., McClintock J.E., 2006, *ARA&A* 44, 49
- Rodriguez L.F., Mirabel I.F., Martí J., 1992, *ApJ* 401, L15
- Rothschild R.E., Blanco P.R., Gruber D.E., et al., 1998, *ApJ* 496, 538
- Scargle J.D., 1982, *ApJ* 263, 835
- Schwarzschild K., 1916, *Sitzber. Preuss. Akad. Wiss.* 189
- Smith D.M., Heindl W.A., Markwardt C.B., Swank J.H., 2001, *ApJ* 554, L41
- Smith D.M., Heindl W.A., Swank J.H., 2002, *ApJ* 569, 362
- Smith I.A., 2010, In: *AAS/High Energy Astrophysics Division #11*, Vol. 42. *Bulletin of the American Astronomical Society*, p.671
- Soria R., Broderick J.W., Hao J., et al., 2011, *MNRAS* 415, 410
- Syunyaev R., Gilfanov M., Churazov E., et al., 1991, *Soviet Astronomy Letters* 17, 50
- Urry C.M., Padovani P., 1995, *PASP* 107, 803
- Whitney A.R., Shapiro I.I., Rogers A.E.E., et al., 1971, *Science* 173, 225
- Xiang J., Lee J.C., Nowak M.A., Wilms J., 2011, *ApJ* in press

Acknowledgements

There are a lot of people without whom this thesis would not have been written. First of all, I want to thank my advisor, Jörn Wilms, who, with his enthusiasm and motivation, made astronomy in general and research in particular a fascinating experience for me. Together with Katja Pottschmidt and Anne Lohfink in Washington and all the others of the Black Hole Collaboration, he patiently answered every of many many questions.

Secondly, the X-ray gang at the Remeis Observatory in Bamberg has to be mentioned: I want to thank my floormates Moritz, Thomas, Christian, Felix and Michael as well as the occupants of the Erlangen offices for a whole bunch of inspiring discussions about science, computers and lots of other topics. They and all the other Remeisen always made me enjoy going to work.

I want to thank in particular Susanne Raab who rescued me by printing this thesis as I was not able to log in to my account.

Last but not least at all, my thanks goes to Heiko who had to have a good deal of patience with me while I spent evenings working and always listened to my complaints about the various problems that occurred. His moral support helped a lot.

Erklärung

Hiermit bestätige ich, dass ich diese Arbeit selbstständig und nur unter Verwendung der angegebenen Hilfsmittel angefertigt habe.

Erlangen,

Maria Obst